

A'PEX SUPER AIRFLOW CONVERTER

S-AFCII SUPER AIRFLOW CONVERTER

INSTRUCTION MANUAL

Thank you for purchasing the A'PEX Super Airflow Converter. Please read through this Instruction Manual to operate this product correctly and keep it near the product so that you may refer to it whenever necessary. If you transfer the product to another customer, be sure to attach this Instruction Manual and the warranty to the product.

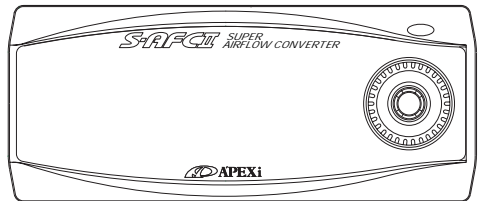

Product name

SUPER AFC

Product code

401-A911 / 401-A913

Applicable car models

Car models mentioned in the wiring diagram by model
Airflow / pressure sensor signal adjustment

Application



A'PEX Chasing Our Dreams - A complete line of customized car and automotive parts developed with state of the art technology and new ideas. Our company is A'PEX which means the highest in quality.

A'PEX CO., LTD

Contents

Chapter 1 Introduction

Safety Precautions	4
Features of this Product	6
Names and Functions of Parts	8
Parts list	8
Names of parts	9
Meanings of operation symbols appearing in this document	9

Chapter 2 Initial Setup

Procedure before Using This Product	12
Perform initial setup	13
Setting the sensor type and sensor number [Sensor Type]	13
Setting the number of cylinders [Car Select]	13
Checking the throttle sensor voltage [Sensor chk]	13
Setting the throttle sensor type [Car Select]	13
Learning the throttle opening	13
Correcting the knocking signal [Knk Set]	13

Chapter 3 Outline of Operating Method

Outline of Functions and Operating Method	16
Functions and Operations in monitor mode	18
Functions and Operations in the setting mode	19
Functions and Operations in the etc. mod	19

Chapter 4 Monitor Mode 【Monitor Menu】

Channel Select [1Channel] ~ [4Channel]	22
A plot display is made by using the RPM for the axis. [Rev.-[Y]]	27

Chapter 5 Setting Mode 【Setting Menu】

Air correction factor setting (Throttle opening, large) [Hi-Thrtl]	30
Air correction factor setting (Throttle opening, small) [Lo-Thrtl]	30
Throttle opening setting [TH-Point]	32
Air correction engine RPM setting [Ne-Point]	34
Deceleration air upper limit setting [Dec.-Air]	36
Knocking signal correction [Knk Set]	38
Data file [Data File]	40

Chapter 6 Etceteras (etc.) Mode 【etc. Menu】

Sensor type and sensor number setting [Sensor Type]	44
Number-of-cylinders and throttle sensor type setting [Car Select]	50
Sensor check [Sensor chk]	52
Display scale setting [Disp Scale]	53
Warning setting [Waning Set]	54
Password setting and change [Pass Lock]	56
VFD brightness adjustment [VFD Bright]	58
Program version check [Program Ver.]	59
All data initialization [Initialize]	60
Troubleshooting	62



Chapter 1 Introduction



Safety Precautions	4
Features of this Product	6
Names and Functions of Parts	8
Parts list.....	8
Names of parts	9
Meanings of operation symbols appearing in this document	9

Safety Precautions

Explanation of indications

	Indication	Meaning
<p>Please read "Safety Precautions" carefully to operate the product with safety. Keep the Instruction Manual in hand and refer to it whenever needed. The Instruction Manual describes the items that you must observe to operate the product without giving any injury to you, other people and damage to property. The meanings of pictorial indications (signal words) are as shown on right. Please understand their contents correctly before starting to read the text.</p>	 WARNING	<p>This indicates the existence of potential hazard that will result in death or serious injury of the operator or a third person if the product is wrongly operated in disregard of this indication.</p>
	 CAUTION	<p>This indicates the existence of potential hazard that will result in slight injury or medium damage to the operator or a third person, and that will result in only physical damage if the product is wrongly operated in disregard of this indication.</p>
	REQUEST	<p>This indicates the contents of a failure in obtaining the full performance of the product, or a product failure or faulty function item if the product is wrongly operated in disregard of this indication.</p>

WARNING

Do not use this product for any application other than applicable vehicles or applicable goods .

We shall disclaim the responsibility for operations in an application other than the applicable vehicles or applicable goods. It will result in an unexpected accident.

If this product gives out any abnormal noise or offensive smell, stop operating the product immediately.

Using the product in this status will result in an electric shock, fire, or damage of electric parts. Consult the distributor or your nearest business office for information.

Do not use this product and its accessories in any way other than specified by A'PEX.

In this case, we shall disclaim all responsibility for any damage or loss to the customer and third persons.

Do not turn on and/or off immediately during and after operating the key Set/recorded data may be lost.

WARNING

The driver must not operate this product during driving
This may interfere with driving operations, resulting in an accident.

Mount this product securely. Do not install it in an unstable place
that may interfere with driving

This may interfere with driving, resulting in an accident.

When installing the product, remove the negative terminal of the
battery beforehand

A fire may be caused by short circuit or electric parts may be damaged or burnt out.

When removing a coupler, be sure to hold the coupler without pulling
the harness

If the harness is pulled, a fire may be caused by short circuit or electric parts may be
damaged or burnt out.

Be sure to perform wiring in accordance with the contents described
in the Instruction Manual

Incorrect wiring will result in a fire or other accidents.

If any adjustment must be made during actual driving, take special
care not to interfere with other traffic, observing the traffic laws and
regulations

It will interfere with driving, resulting in an accident.

CAUTION

Regarding the installation of this product, be sure that it is installed
by an experienced professional
Installing the product requires technical knowledge and skill. Be sure that the installer
installs the unit securely.

Do not tamper, disassemble, or modify this product

This may cause an accident, fire, electric shock, or electric parts will be damaged or
burnt out.

Do not drop this product or expose it to strong shock

This may cause a malfunction, thereby giving damage to the product and the vehicle.

Do not operate this product under direct sunlight or in high-temperature
vehicle interiors that are not air-conditioned in the summer season
A malfunction will be caused, thereby giving damage to the product and the vehicle.

Do not install the product in a high-temperature place or in a place
exposed to direct water

It will cause an electric shock or fire, or electric parts will be damaged. The malfunction
may damage the vehicle.

Features of this product

The SUPER AFC II is a fuel adjustment controller in which the airflow sensor signal or the pressure sensor signal can be modified in a 12 point RPM range by 1% increments to increase/decrease fuel in a range of +50% to -50%. The RPM to be corrected can be optionally set in 200 RPM increments, and corrections can be made according to throttle opening amounts. In a turbo equipped vehicle with a hot wire type airflow meter, this controller provides a preventive function for engine stall due to blow-back during throttle return. The controller, which includes a knocking meter, allows the monitoring of knock levels check keeping the engine under its optimum condition at all times. (Vehicle must have a factory knock sensor)

Unconventional large screen monitor using a high-brightness VFD

The futuristic front face of this unit uses the large screen, high-brightness and easy to read VFD (Vacuum Fluorescent Display)

Use of the dot-matrix large screen monitor allows the displaying several types of information simultaneously. Display variations are not limited to only numeric value display, but also graph display, analog display, and other various displays are shown. This allows the driver to recognize important information in an instant.

Utilizes a thin case and single button

A thin case of 52 mm(L) x 126 mm(W) x 18 mm (D) (Minimum) has been achieved by optimization of the circuit board and case design. The product can be easily installed on the steering column or dash board. Since there is no separate unit besides the main unit, it is not necessary to secure a place for installing any separate unit. Using a 4-direction switch with a center pushbutton and a rotary switch gets rid of the button-to-button distance and permits quick operations, thereby providing efficient operation of the unit.

Battery-less memory that can keep initial setup data in the memory even if the vehicle battery is disconnected

With the use of the EEPROM, the initial setup data is not lost unless initialization is performed, even if the power supply is turned off or the vehicle battery is disconnected. The setting data, such as peak value and correction value, is never lost. Accordingly, if the vehicle battery is disconnected for service inspection, initial setup and settings do not need to be performed again and the data history is not lost.

CAUTION

This product cannot be used for any application other than the vehicles mentioned in the separate Vehicle Specific Application Charts.

Note that noise interference may be caused to radio, TV, etc. depending on the mounting location of this product and the routing of the signal harness.

This product generates heat in the power ON status. This is not abnormal.

Storing two patterns of setting data in the memory

Two patterns of setting data including air correction factor, throttle opening, air correction engine revolution speed, deceleration air upper limit, etc, can be stored in the memory. There are two files that can be stored in the memory. The setting data can be selected in an instant according to each driving stage such as circuit driving, town driving, and winding driving. When driving on the same stage, two patterns of setting data can be compared. These patterns of setting data can be used for various purpose.

Setting disable function by password

If the setting data or initial set points are changed by disoperation or mischief, the car condition may be deteriorated, or in the worst case, the engine may be damaged. In the SAFC II, when the user sets a password optionally, changing the setting data or initial setup items is disabled.

Warning function to make hazard known

It is possible to set warning values for the airflow using ratio, suction tube pressure, Karman swirl sensor frequency, knocking, and engine revolution speed.

When each item is set, the car condition can be precisely judged. The setting for the engine speed can also be used as a shift timing point.

Knocking

Spontaneous ignition is caused by the heat and pressure of mixed air in the burning portion of non-combustion gas which is far from the plug and the heat of combustion chamber wall, so that the gas in the whole combustion chamber generates high-pressure waves momentarily. In this phenomenon, strong metallic noise is output from the engine unlike car knocking by which the car body becomes jerky, with the result that the valve is damaged and the piston is seized, thereby giving fatal damage to the engine.

As countermeasures, fuel adjustment, ignition timing adjustment, compression ratio adjustment, improvement of intake-side squish area, use of mirror type combustion room wall, and profile improvement of the exhaust-side cam shaft can be mentioned.



WARNING

During driving, the driver must not operate this product in any case.









It will interfere with driving operations or result in an accident.

On general public roads, observe the road and traffic law to drive the car carefully.

Names and Functions of Parts

Parts list

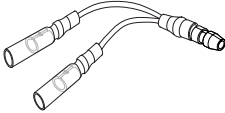
Before installing this product, be sure to check the parts list to confirm that there are not any foreign or missing parts. If any difference is found between the actual parts and the parts list, please contact the dealer of purchase.

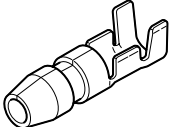
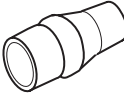
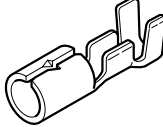
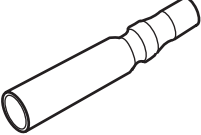
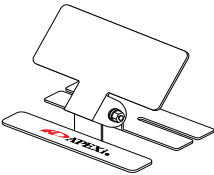
1.Main unit 	2.Instruction manual(Operation part) 	3.Wiring diagram by model 	4.Operation transition diagram 
1unit	1volume (this document)	1volume	1sheet
5.Warranty 	6.Signal harness 	7.Splitting harness 	8.Splice 
1sheet	1sheet	1piece	6pieces
9.Plug 	10.Male sleeve 	11.Plug receptacle 	12.Female sleeve 
4pieces	4pieces	4pieces	4pieces
13.Mounting stay 			
1pieces			

Names of parts

VFD display section

Optical sensor
(CDS sensor)

4-direction switch with
a center pushbutton

Rotary switch

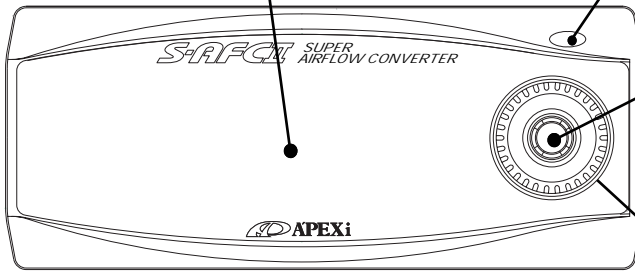

Meanings of operation symbols appearing in this document



Press the upper part of the center switch



Press the lower part of the center switch



Press the left part of the center switch



Press the right part of the center switch



Press the center pushbutton



Turn the rotary switch counterclockwise or clockwise

When the rotary switch is turned clockwise, the numeric value shifts in the positive direction or the cursor moves upward.

When the rotary switch is turned counterclockwise, the numeric value shifts in the negative direction and the cursor moves downward. The upper/lower part of the center switch has the same function as the rotary switch.

Popup menu

When you press the center pushbutton, the popup menu shown at right appears. The selected portion will appear as a reverse display. Make a selection by the upper/lower/left/right part of the center switch and decide the selection by pushing the center push button.



Example)



Press the center pushbutton and select [Nx] in the popup menu.

The meanings of alphabetic characters are as follows;

T p [TOP] Go back to the main menu

N x [NEXT] Go to the next

P r [PREVIOUS] ... Go back to the previous

C n [CANCEL] Cancel the popup menu

Chapter 2 Initial Setup

Procedure before Using This Product _____	12
Perform initial setup _____	13
Setting the sensor type and sensor number	13
Setting the number of cylinders	13
Checking the throttle sensor voltage	13
Setting the throttle sensor type	13
Learning the throttle opening	13
Correcting the knocking signal	13

Procedure before Using This Product

Install this product

The details of the installation procedure are described in the separate “Vehicle Specific Wiring Diagram.” Install the product securely referring to the “Vehicle Specific Wiring Diagram” in a separate document.



Turn on the ignition switch

Make sure that any abnormal noise or offensive smell is not produced from the SAFC II and the Vehicle.



Perform initial setup

Perform initial setup securely by referring to page 13.



Turn the ignition switch off

The setting data is stored in the memory.



Start the engine



CAUTION

If no display appears, or any abnormal noise or offensive smell is produced from this product despite proper installation, discontinue operation of the product immediately and contact the dealer of purchase.

Perform initial setup

To operate this product, you must set several items during initial setup.

After making sure that the SAFC II is securely installed, turn on the ignition switch and select the ETC. (etc. mode) in the main menu.

Table of initial setup items

- 1 . Setting the sensor type and sensor number (P.44 [Sensor Type])
Select Sensor Type and set the sensor type and sensor number
For vehicles equipped with a hot wire sensor, set the sensor output calculation method.
- 2 . Setting the number of cylinders (P.50 [Car Select])
Select Sensor Type and set the number of cylinders.
You can select it in the range of 1 to 16 cylinders.
Rotary engine car: Number of rotors \times 2
Toyota V8 engine car: 4
Nissan Fairlady Z (Z33) Skyline (CPV35): 1
Mazda Atenza (GG#S/P, GY#W): 2
For a car without throttle sensor signal, start operations from 6.
- 3 . Checking the throttle sensor voltage (P.52 [Sensor chk])
Select Sensor chk and check the throttle sensor voltage with the throttle fully closed and once with the throttle fully open.
- 4 . Setting the throttle sensor type (P.50 [Car Select])
Select Car Select. When the throttle sensor voltage is 0 V to 1 V fully closed in the previous step, set the arrow to the upward direction. When the throttle voltage is 3 V to 5 V, set the arrow to the downward direction. When the arrow is set to the mark, no correction is performed by throttle opening.
- 5 . Self learning the throttle opening
Self learn the throttle opening. Hold the throttle fully closed for about 10 seconds.
After that, hold the throttle fully open for about 10 seconds.
- 6 . Turn off the ignition switch
When the ignition switch is turned off, the set items are stored in the memory
After this, the initial setup is completed for a car without any knocking signal. For, a car with a knocking signal, perform setting 7.
- 7 . Correcting the knocking signal (P.38 [Knk Set])
Start the engine and perform warming-up. After completion of warming-up, select Setting (setting mode) in the SAFC II main menu and select the knocking signal correction mode. Correct the knocking signal.

With this, the initial setup is completed.

WARNING

Do not start the engine before starting the initial setup
If the engine is started without initial setup, the engine may be damaged.

Chapter 3

Outline of Operating Method



Outline of Functions and Operating Method	16
What to be performed in the monitor mode	18
What to be performed in the setting mode	19
What to be performed in the etc. mode	19

Outline of Functions and Operating Method

Main menu

The SAFC consists mainly of 3 menus;

Main

- 1. Monitor
- 2. Settings
- 3. etc.

Monitor mode

The data obtained from the sensor is displayed

```
Monitor Menu
1channel
2channel
3channel
4channel
Rev.-[Y]
```

The airflow usage ratio, intake pressure, Karman sensor frequency, throttle opening, engine RPM, air correction factor, knocking level, and battery voltage are displayed.

Setting mode

This mode is used for the user to perform settings

```
Settings Menu
1. Hi-Thrtl
2. Lo-Thrtl
3. TH-Point
4. Ne-Point
5. Dec.-Air
6. Knk Set
7. DataFile
```

The air correction factor, throttle opening, air correction, engine RPM, and the upper limit for deceleration air is set. Knocking signal correction and data file are also controlled.

etc. mode

This mode is used to perform various settings including initial setup

```
etc. Menu
1. Sensor Type
2. Car Select
3. Sensor chk
4. Disp Scale
5. WarningsSet
6. Pass Lock
7. VFD Bright
8. ProgramVer
9. Initialize
```

The initial setup, display scale setting, and warning settings are set according to the vehicle specifications, and the pass word setting/change, VFD brightness adjustment, and initialization are performed.



[Channel 1 to Channel 4] display items

1. AflAirflow (Hot wire/Flap) usage ratio
2. Prs Intake pressure
3. KarKarman sensor frequency
4. Thr Throttle opening
5. Rev Engine RPM
6. Cor Air correction factor
7. Knk Knocking level
8. Bat Battery voltage

Rev. - [Y] display item

A plot display is made by using the engine RPM for the axis



Setup items

1. Hi-ThrtlAir correction factor setting (throttle opening, large)
2. Lo-Thrtl Air correction factor setting (throttle opening, small)
3. TH-Point..... Throttle opening setting
4. Ne-Point..... Air correction engine RPM setting
5. Dec.-Air Deceleration Air upper limit setting
6. Knk Set.....Knocking signal correction
7. Data File Data file control



Setup items

1. Sensor Type..... Sensor type and sensor number setting
2. Car SelectNumber-of-cylinders and throttle type setting
3. Sensor chkSensor check
4. Disp Scale..... Display scale setting
5. Warning Set Warning output setting
6. Pass Lock.....Password setting/change
7. VFD Bright VFD brightness adjustment
8. Program Ver..... Program version check
9. Initialize..... All data initialization

Main menu **【Monitor】****Functions and Operations in the monitor mode****【One of items 1 to 4 is selected and displayed】**P22 . **【Monitor】 【1Channel】 ~ 【4Channel】**

[Contents of items]_____

1. AflAirflow (Hot wire/Flap) usage ratio
2. Prs..... Intake pressure
3. Kar Karman sensor frequency
4. Thr..... Throttle opening
5. Rev..... Engine RPM
6. Cor Air correction factor
7. Knk..... Knocking level
8. BatBattery voltage

[Display method]_____

Numeric display/analog display : Real-time display, peak hold display, and pause.

Graphic display : Real-time display, replay, and pause.

Digital/analog display : Real-time display, peak hold display.

NOTE

Regarding the 3 items Afl, Prs, and Kar, the contents that can be displayed depend on the intake air volume measuring equipment of the vehicle. For example, in the case of a car equipped with a hot wire type airflow sensor, Afl can be displayed but Prs is not displayed.

【A plot display is made by using the engine RPM for the axis】P27 . **【Monitor】 【Rev.-[Y]】**

[Contents of the axis] One of the 5 items is selected and displayed.

1. Air Flow Airflow (Hot wire/Flap) usage ratio
2. Pressure Intake pressure
3. Karman Karman sensor frequency
4. Throttle..... Throttle opening
5. Correct..... Air correction factor

[Display method]_____

1-point display, 10-point display, and locus display
 Real-time display, replay, and pause.

Main menu 【Setting】

Functions and Operations in the setting mode

- | | |
|--|-----|
| 1. Hi-Thrtl | P30 |
| Air correction factor setting (throttle opening, large) | |
| 2. Lo-Thrtl | P30 |
| Air correction factor setting (throttle opening, small) | |
| 3. TH-Point | P32 |
| Throttle opening setting | |
| 4. Ne-Point | P34 |
| Air correction engine revolution speed setting | |
| 5. Dec-Air | P36 |
| Reduction gear upper limit setting (for the hot wire car only) | |
| 6. Knk Set | P38 |
| Knocking signal correction | |
| 7. Data File | P40 |
| Data file control | |

Main menu 【etc.】

Functions and Operations in the etc. mode

- | | |
|--|-----|
| 1. Sensor Type..... | P44 |
| Sensor type and sensor number setting | |
| 2. Car Select | P50 |
| Number-of-cylinders and throttle sensor type setting | |
| 3. Sensor chk | P52 |
| Sensor check | |
| 4. Disp Scale | P53 |
| Display scale setting | |
| 5. Warning Set | P54 |
| Warning setting | |
| 6. Pass Lock..... | P56 |
| Password setting/change | |
| 7. VFD Bright..... | P58 |
| VFD brightness adjustment | |
| 8. Program Ver. | P59 |
| Program version check | |
| 9. Initialize..... | P60 |
| All data initialization | |

Chapter 4 Monitor Mode



One of items 1 to 4 is selected and
displayed _____ 22
A plot display is made by using the RPM
for the axis _____ 27



【Monitor Menu】 【1Channel】 ~ 【4Channel】

Channel Select

Of the following 8 items, one of channels 1 to 4 is selected and displayed. A numeric display, analog display, graphic display, and digital/analog display are available as the display method. A pause is also available in each display (except the digital/analog display). In the numeric display, analog display and digital display, peak hold can be performed. In the graphic display, replay (*) can be performed.

[Note]The replay function stores the last saved display in the memory. Accordingly, even if the display item is changed, the last saved item display is replayed, regardless of the display item.

Contents of display items

- | | | |
|--------------------------------|-----------------------------|----------------------------------|
| 1. Afl.....Airflow usage ratio | 2. Prs..... Intake pressure | 3. Kar Karman sensor |
| 4. Thr..... Throttle opening | 5. Rev..... Engine RPM | 6. Cor.....Air correction factor |
| 7. Knk.....Knocking level | 8. Bat..... Battery voltage | |

Numeric display example

【Function】 Pause and peak hold

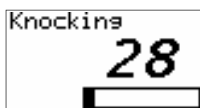

1-channel display

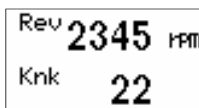

2-channel display

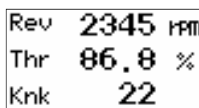

3-channel display

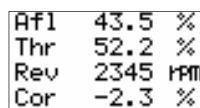

4-channel display

Analog display example

【Function】 Pause and peak hold



1-channel display

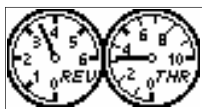

2-channel display

Digital/analog display

example 【Function】 Peak hold



Common display to all channels

Graphic display

【Function】 Pause and replay

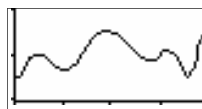

1-channel display

1. Select [Monitor] in the main menu

2. Select [1 to 4 Channel] in the monitor menu



Main menu

Select Enter

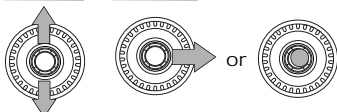

Monitor menu

Select Enter

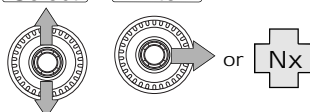

- 1-item data display
- 2-item data display
- 3-item data display
- 4-item data display



When the upper part of the center switch is pressed, the operation is the same as when the rotary switch is turned clockwise. When the lower part of the center switch is pressed, the operation is the same as when the rotary switch is turned Counterclockwise.

3. Select the data to be display in the item selection menu

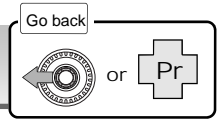

When selecting [1 Channel]

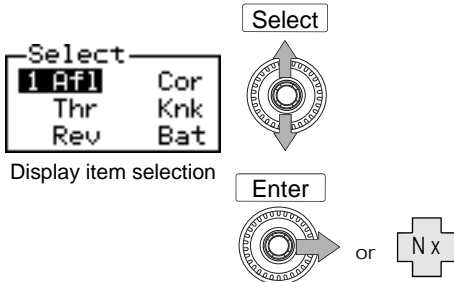

- (1) Select a display item
Operate the upper part or lower part of the switch in the display item selection mode to select a display item. The selected item is displayed as a reversing display.
- (2) Make a display
Press the right part of the switch or press the center pushbutton to make a display.

When selecting [2 to 4 Channel]

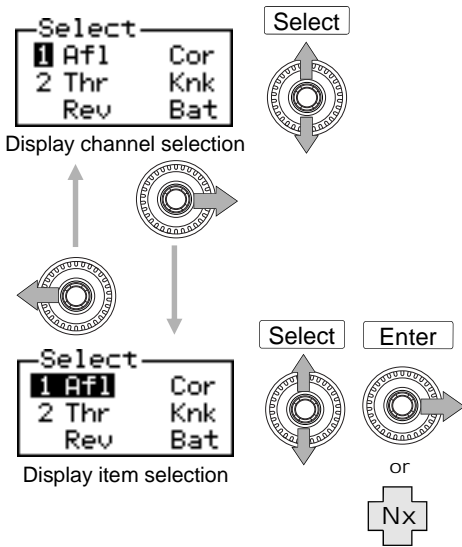

- (1) Select a display channel
Operate the upper part or lower part of the switch in the display channel selection mode to select a display channel. The number of the selected channel is displayed as a reserving display.
- (2) Select a display item
Select a display channel and operate the right part of the switch to set the display item selection mode. The numeric value of channel and the display item are displayed as a reversing display. In this status, operate the upper part or lower part of the switch to select a display item.
- (3) Select a display item of another channel
Operate the left part of the switch in the display item selection mode to go back to the display channel selection mode. Repeat steps (1) and (2) until all the display items are set.
- (4) Make a display
Operate the right part of the switch in the display item selection mode, or press the center pushbutton in the display channel selection mode and select [Nx] in the popup menu to make a display.

The above display screen example is displayed when the sensor type is a hot wire type or a flap type and [2 Channel] is selected.

Hold down the lower part of the center switch to display the air correction factor (P30) setting screen. Hold down the lower part of the center switch on the air correction factor setting screen to go back to the monitor display.

4 The selected item is displayed in the item selection menu



Each time the center push button is pressed and [Nx] is pressed in the popup menu, (numeric display) → (graphic display) → (analog display) → (digital/analog display) → (numeric display) ... is selected in sequence.

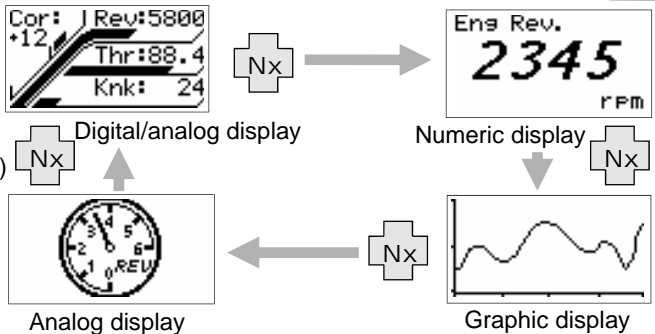

Function at numeric display and analog display

For the analog display, up to 2 items are displayed. When [3 Channel] or more is selected, selection No.1 and 2 are displayed

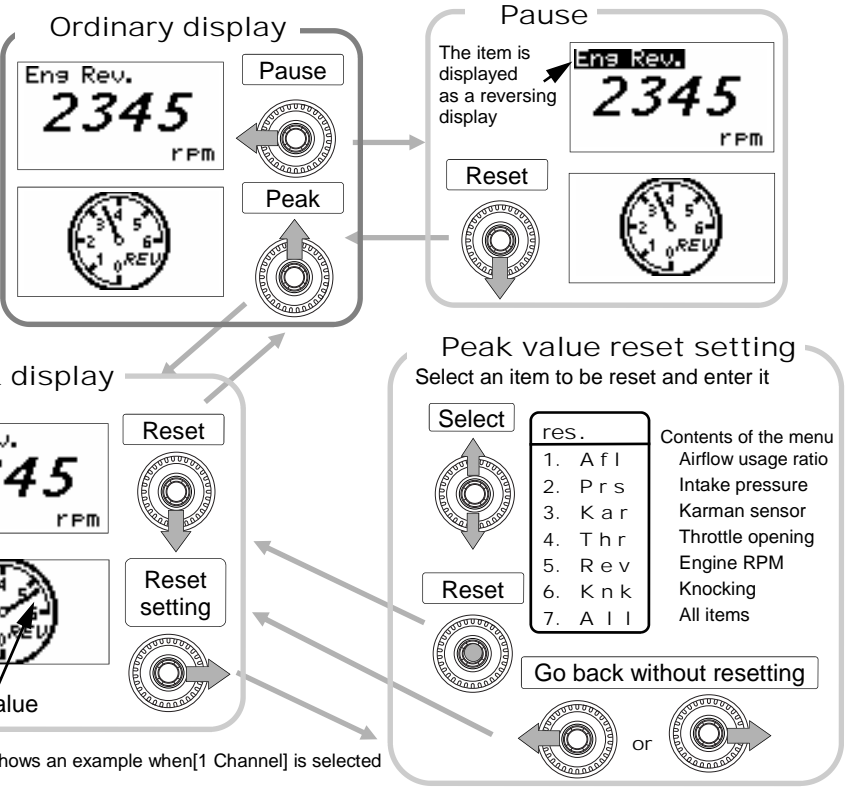

The figure shows an example when [1 Channel] is selected

Function at graphic display

The following figure shows an example when [1 Channel] is selected.

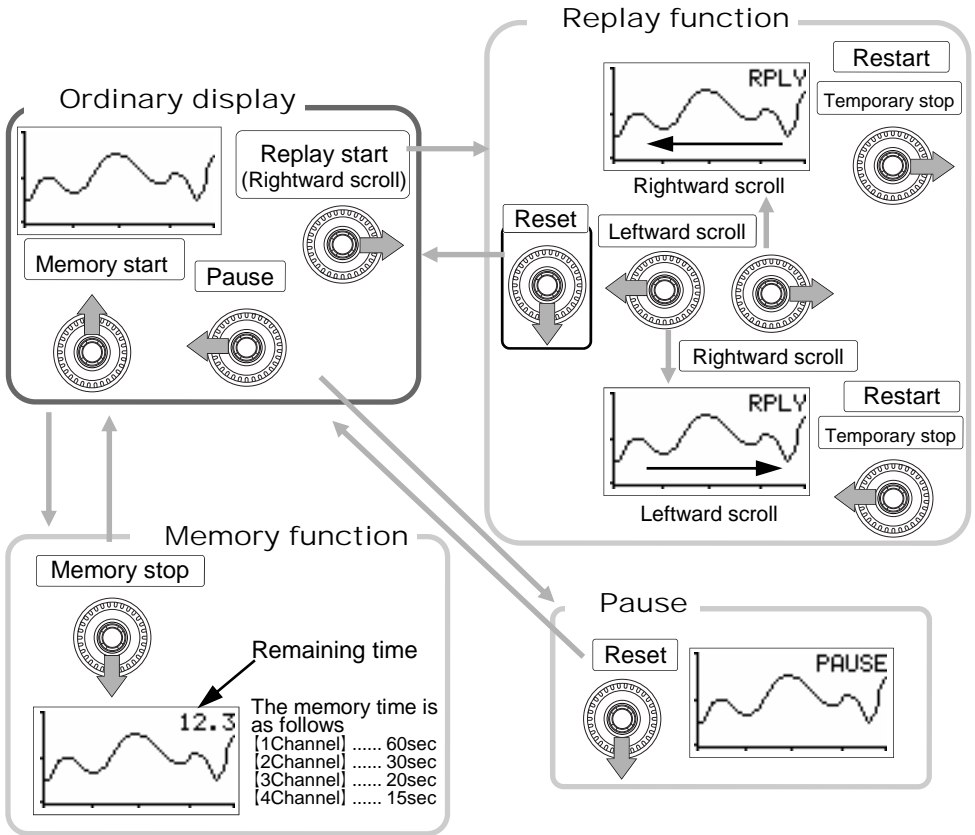

NOTE

Regarding the 3 items Afl, Prs, and Kar, the contents that can be displayed depend on the intake air volume measuring equipment of the vehicle. For example, in the case of a car provided with a hot wire type airflow sensor, Afl can be displayed but Prs cannot be displayed.

Function in the digital/analog display

In the digital/analog display, a 4 channel display is made regardless of the selected channel. The display items are fixed to the 4 items: engine RPM, throttle opening, knocking level, and air correction factor.

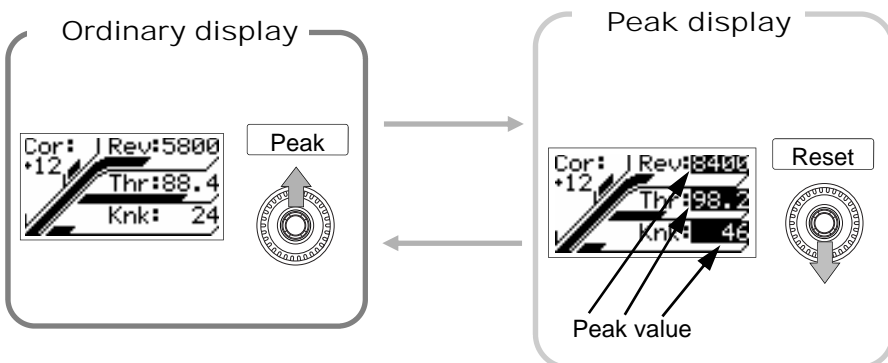

The numeric display blinks?!

Check if warning function is set

When Rev [engine RPM], Knk [Knocking level], or other parameter is displayed, the numeric value blinks as a reversing display after it exceeds the set the RPM or the preset level. (P.54)

The numeric display or analog display cannot be moved?!

Check if pause function is set

If Pause is set, the numeric display or analog display will not move. Operate the lower part of the center switch to reset the pause status.

【Monitor Menu】 【Rev.-[Y]】

A plot display is made by using the RPM for the axis

1 Select [Monitor] in the main menu

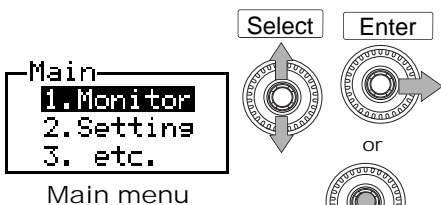

2 Select [Rev. -[Y]] in the monitor menu

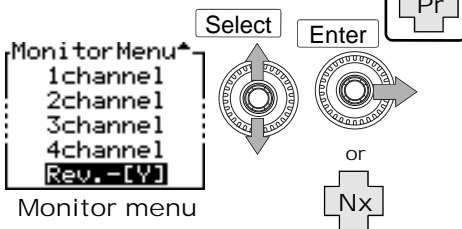

3 Select the data to be displayed in the item selection menu

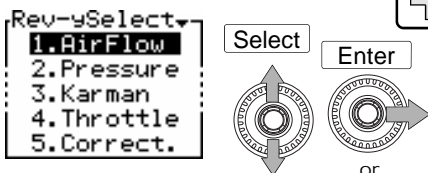

4 The selected item is displayed in the item selection menu

Press the center pushbutton. Each time [Nx] is pressed in the popup menu, (1-point display) → (10-point display) → (Map trace display) → (1-point display) is selected in sequence

1. Airflow.....Airflow usage ratio
2. PressureIntake pressure
3. KarmanKarman sensor frequency
4. Throttle.....Throttle opening
5. Correct.....Air correction factor

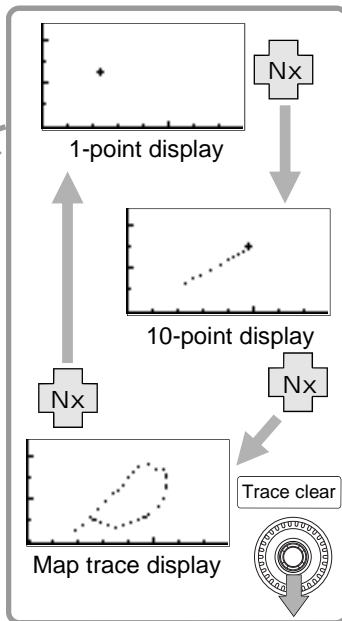
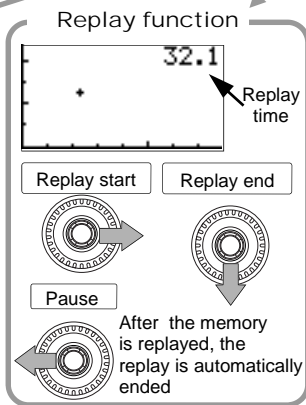
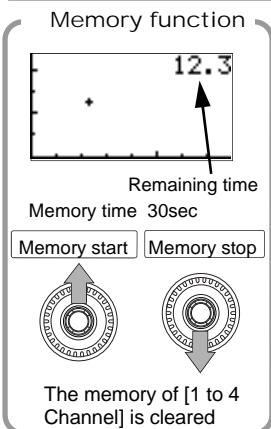

Chapter 5

Setting Mode

Air correction factor setting (Throttle opening, large) _____	30
Air correction factor setting (Throttle opening, small) _____	30
Throttle opening setting _____	32
Air correction engine RPM setting _____	34
Deceleration air upper limit setting _____	36
Knocking signal correction _____	38
Data file _____	40

【Setting Menu】 【Hi-Thrtl】 · 【Lo-Thrtl】

Air correction factor setting (Throttle opening, large / small)

In the SAFC, the input airflow signal is converted into an air volume value and this value is corrected by the air correction factor. As an output signal, the corrected air volume value is converted back into an airflow signal and then this signal is output to the electronic control unit (ECU).
 Accordingly, supposing that the correction factor is +10%, the ECU recognizes that the air volume has increased 10%, so fuel is increased about +10%.
 For air correction factor setting, the air correction factor can be adjusted by 1% increments in the correction range of +50% to -50% for each engine RPM at 12 points. It can also be set according to the throttle opening level.

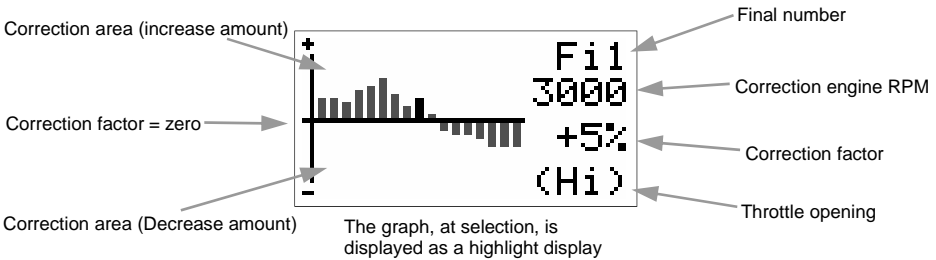

1. Select [Setting] in the main menu

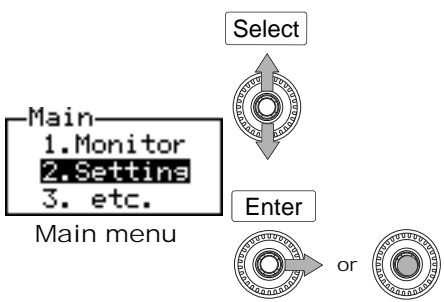

2. Select [Hi / Lo-Thrtl] in the setting menu

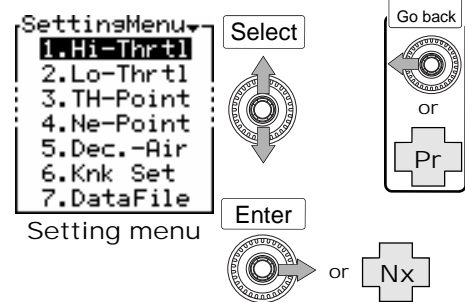

⚠ WARNING

Do not operate this product while driving
 It will interfere with driving operations, resulting in an accident.

When the upper part of the center switch is held down on the air correction factor setting screen, the set correction value is put into the flat (correction) status. The set value is returned to the initial status by holding down the upper part of the same switch once again.

3. The air correction factor setting mode is set



Ordinary display image diagram

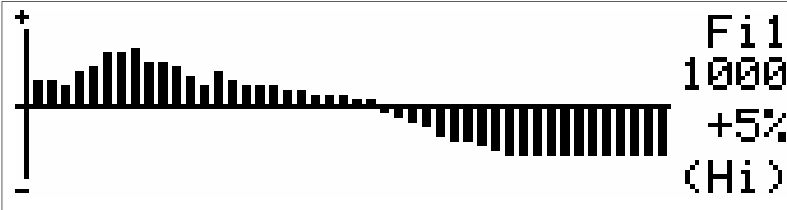

The ordinary display setting screen is as shown in the above image diagram. The actual display is shown in the lower left figure. The screen is scrolled by pressing the left or right part of the center switch. If either the upper part or the lower part of the center switch is pressed during the ordinary display, this display is changed into a reduced display as shown in the lower right figure. In this case, all setting graphs are displayed on a single screen. The reduced display can be changed into the ordinary display by pressing either the upper part or the lower part of the center switch.

Actual ordinary display

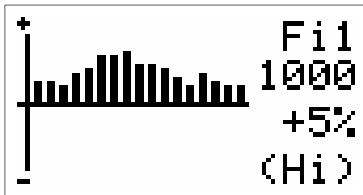

Display changeover



Reduced display

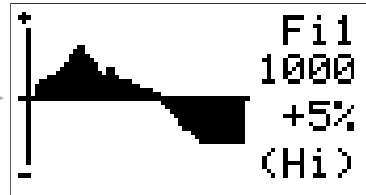

RPM selection



Correction factor increase/decrease



Like the ordinary display and reduced display, the engine RPM is selected by the left or right part of the center switch, and the correction factor is increased or decreased by the rotary switch. When the rotary switch is turned clockwise, the graph is shifted in the positive direction (increase). When the rotary switch is turned counterclockwise, the graph is shifted in the negative direction (decrease).

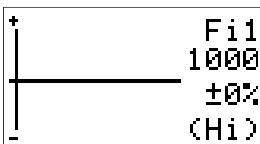

【Hi-Thrtl】

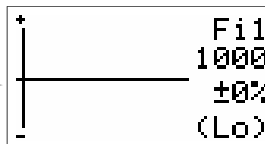

【Lo-Thrtl】

Each time [Nx] is pressed in the popup menu after the center pushbutton is pressed, the Hi-Thrtl mode and the Lo-Thrtl mode can be switched over to each other.

Throttle opening setting

1. Select [Setting] in the main menu

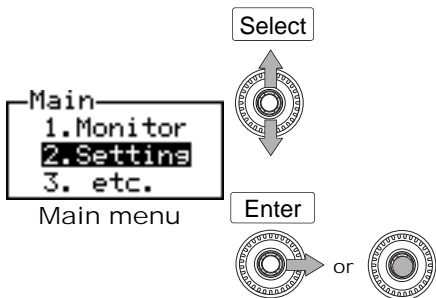

2. Select [TH-Point] in the setting menu

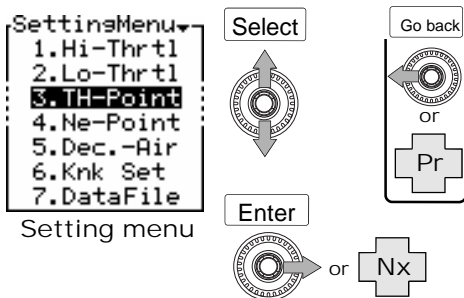

3. The throttle opening setting mode is set

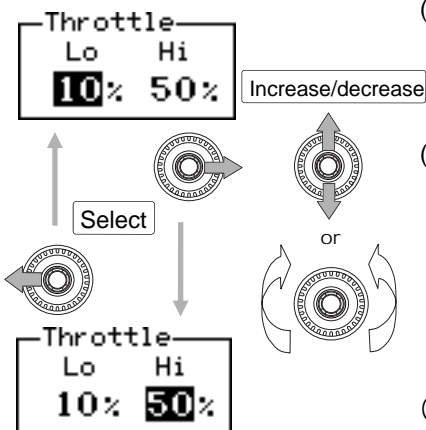
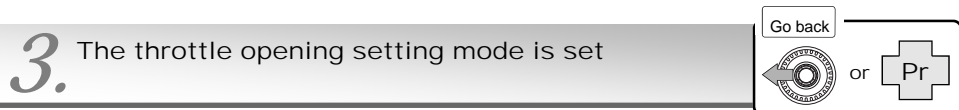

- (1) Select the throttle opening Lo/Hi
Operate the left/right part of the center switch to select the throttle opening Lo or Hi. The selected numeric value is displayed as a reversing display.
- (2) Select a numeric value
Select a numeric value and press the upper or lower part of the center switch or turn the rotary switch counterclockwise or clockwise to increase or decrease the numeric value. When the rotary switch is turned clockwise, the numeric value is increased. When this switch is turned counterclockwise, the numeric value is decreased.
- (3) End the setting
Select [Pr] in the popup menu after pressing the center pushbutton or press the left part of the center switch at throttle opening Lo selection and the setting menu will reappear.

Setting range The value in parentheses is the initial value

Lo 【Throttle opening, small】 0 ~ 98 (10) [%]
Hi 【Throttle opening, large】 1 ~ 99 (50) [%]

Settable by 1% increments

Correction factor change due to throttle opening setting.

When the throttle opening is set to Lo-10% and Hi-50%, the air correction factor at a throttle opening of 40% is as follows;

Throttle	
Lo	Hi
10%	50%

At a throttle opening of 50% or more, the air correction factor is equal to "Correction factor set at Hi-Thrt +3%"

At a throttle opening of 10% or less, the air correction factor is equal to "Correction factor set at Lo-Thrt -1%"

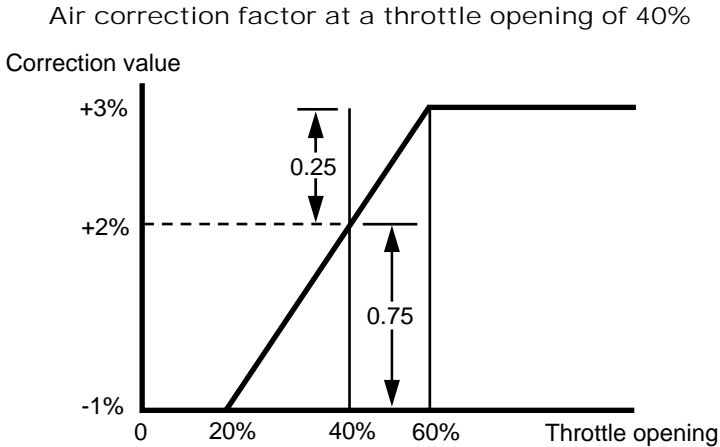

The air correction factor at a throttle opening of 40% can be obtained by the following formula;

$$\frac{(3\% - (-1\%)) \times (40\% - 10\%)}{50\% - 10\%} + (-1\%) = 2\%$$

Air correction engine RPM setting

1. Select [Setting] in the main menu

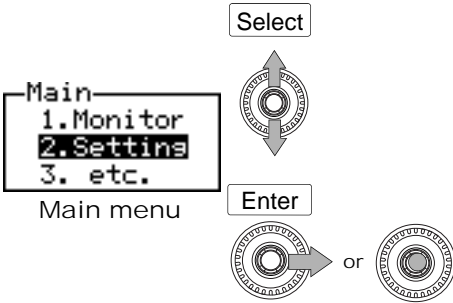

2. Select [Ne-Point] in the setting menu

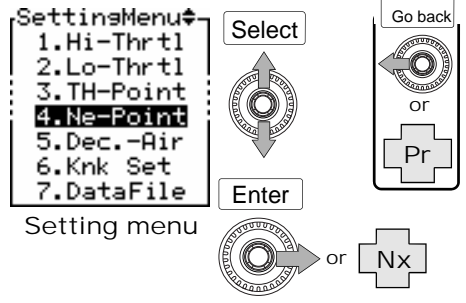

3. The air correction engine RPM setting mode is set

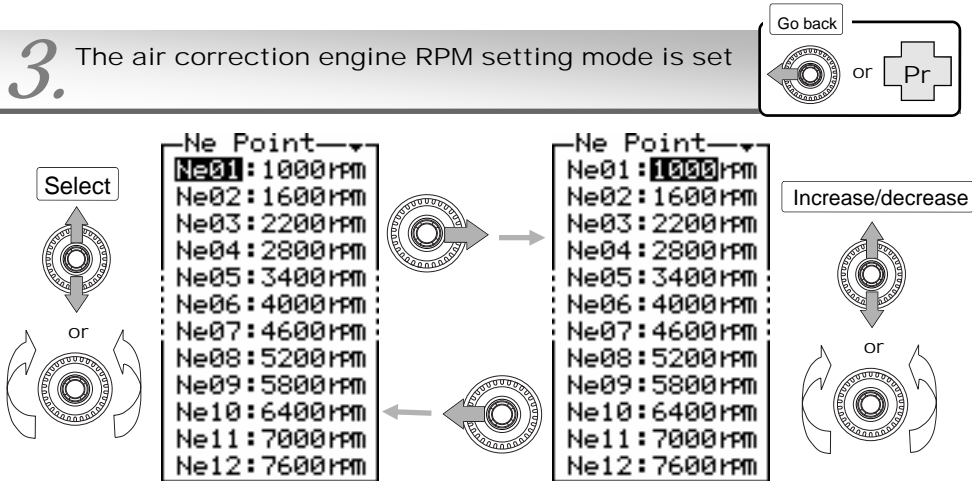

Ne : Engine RPM

Ne01 < Ne02 < Ne03 < Ne04 < Ne05 < Ne06 < Ne07 < Ne08 < Ne09 < Ne10 < Ne11 < Ne12

For Ne02, the engine revolution speed cannot be set to a lower value than that of Ne01. The same can be said for the other revolution points,

Setting range The value in parentheses is the initial value

Ne Point 【Engine revolution point】 800 ~ 9800 [rpm]
(1000.1600.2200.2800.3400.4000.4600.5200.5800.6400.7000.7600)

Settable by 200 rpm steps

(1) Select an engine RPM point

Press the upper or lower part of the center switch or turn the rotary switch counterclockwise or clockwise to select an engine RPM point. The selected item is displayed as a reversing display. When the rotary switch is turned clockwise, the cursor is moved upward. When this switch is turned counterclockwise, the cursor is moved downward.

(2) Set the engine RPM

Select an engine revolution point and press the right part of the center switch to set the engine RPM. When the upper or lower part of the center switch is pressed or the rotary switch is turned counterclockwise or clockwise, the numeric value is increased or decreased.

When the rotary switch is turned clockwise, the numeric value is increased. When this switch is turned counterclockwise, the numeric value is decreased.

For setting another engine RPM point

Operate the left part of the center switch and repeat steps (1) and (2).

(3) End the setting

Select [Pr] in the popup menu after pressing the center pushbutton or press the left part of the center switch at engine RPM point selection (No.01 to No.12), and the setting menu will reappear.

How to make a correction by engine RPM setting and throttle opening setting.

Setting example			Ne												
			Ne01	Ne02	Ne03	Ne04	Ne05	Ne06	Ne07	Ne08	Ne09	Ne10	Ne11	Ne12	
Thr	(Hi)	80%	Hi	2	4	3	3	6	8	9	9	7	5	3	1
	(Lo)	30%	Lo	-4	-2	0	1	2	2	1	0	-1	-2	-3	-3

		Engine revolution speed (rpm)												
		1000	1600	2200	2800	3400	4000	4600	5200	5800	6400	7000	7600	
Accelerator opening(%)	0	-4	-2	0	1	2	2	1	0	-1	-2	-3	-3	At an opening below Lo-Thrtl, the same correction factor is applied.
	10	-4	-2	0	1	2	2	1	0	-1	-2	-3	-3	
	20	-4	-2	0	1	2	2	1	0	-1	-2	-3	-3	
	30	-4	-2	0	1	2	2	1	0	-1	-2	-3	-3	At an opening between Hi-Thrtl and Lo-Thrtl, linear interpolation is applied.
	40	-2.8	-0.8	0.6	1.4	2.8	3.2	2.6	1.8	0.6	-0.6	-1.8	-2.2	
	50	-1.6	0.4	1.2	1.8	3.6	4.4	4.2	3.6	2.2	0.8	-0.6	-1.4	
	60	-0.4	1.6	1.8	2.2	4.4	5.6	5.8	5.4	3.8	2.2	0.6	-0.6	
	70	0.8	2.8	2.4	2.6	5.2	6.8	7.4	7.2	5.4	3.6	1.8	0.2	
	80	2	4	3	3	6	8	9	9	7	5	3	1	At an opening over Hi-Thrtl, the same correction factor is applied.
	90	2	4	3	3	6	8	9	9	7	5	3	1	
	100	2	4	3	3	6	8	9	9	7	5	3	1	

Deceleration air upper limit setting

In the case of a turbo vehicle equipped with a hot wire type airflow sensor, the engine may be stalled by blow-back when the throttle is released. In this case, engine stall can be prevented by using the deceleration air upper limit setting. With the deceleration air upper limit setting, an upper limit is given to the airflow output voltage at the engine RPM set at Ne01 and Ne02 (Ne01 and Ne02 of Ne-Point) below the "Thr" throttle opening.

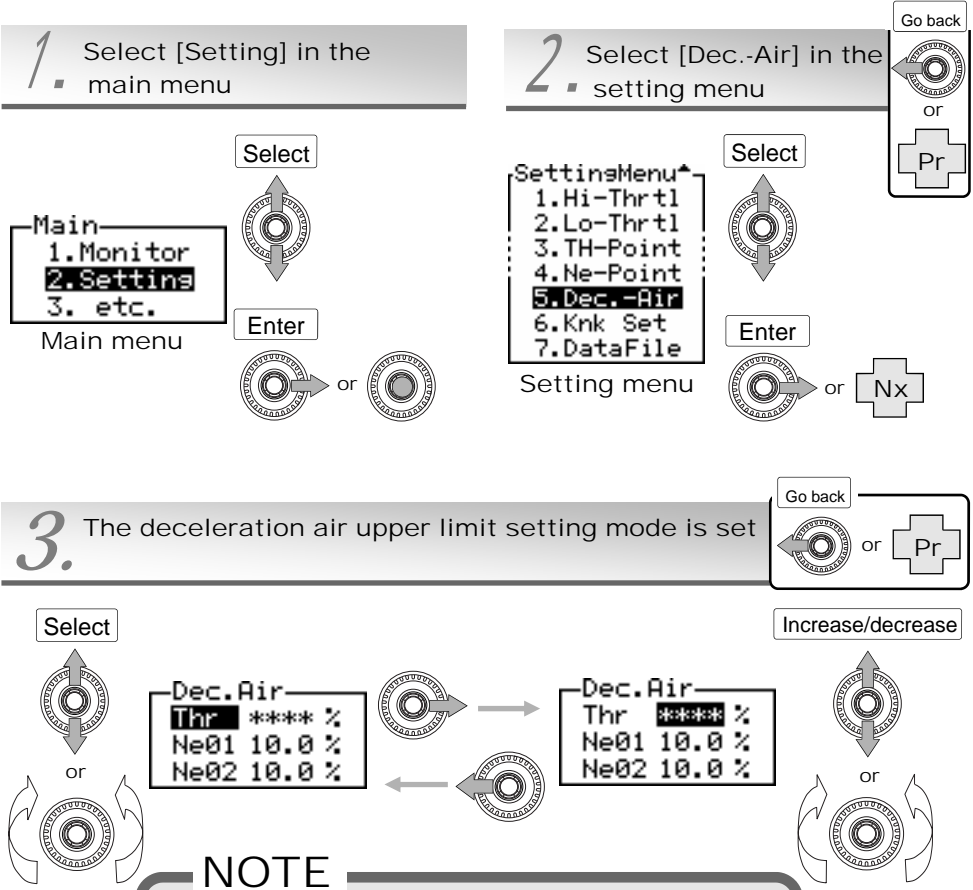

NOTE

At an engine RPM over Ne02, deceleration air upper limit setting is not active.
 When Thr is * * * *, deceleration air upper limit setting is not active.

- (1) Select a throttle opening and an engine RPM

Press the upper or lower part of the center switch or turn the rotary switch counterclockwise or clockwise to select an engine RPM point. The selected item is displayed as a reversing display. When the rotary switch is turned clockwise, the cursor is moved upward. When this switch is turned counterclockwise, the cursor is moved downward.
- (2) Set a numeric value

Select each item and press the right part of the center switch. The throttle opening can be set by Thr and the upper limit of airflow usage ratio can be set by Ne01 and Ne02. When the upper or lower part of the center switch is pressed, or the rotary switch is turned counterclockwise or clockwise, the numeric value is increased or decreased. When the rotary switch is turned clockwise, the numeric value is increased. When this switch is turned counterclockwise, the numeric value is decreased.
- (3) End the setting

Select [Pr] in the popup menu after pressing the center pushbutton or press the left part of the center switch at item selection (Thr, No.01 and No.02), and the setting menu will reappear.

Setting Dec.-Air

1. Ne01 / Ne02 RPM check

Turn on the ignition switch, and check the Ne01/Ne02 RPM at air correction point setting [Ne-Point]. The initial value is 1000 rpm for Ne01 and 1600 rpm for Ne02.
2. Thr / Afl / Rev check

In the monitor mode [Monitor], make a selection so that the throttle opening (Thr), engine RPM (Rev), and airflow usage ratio (Afl) may be displayed. Start the engine and set the gear to the neutral position. Before the engine is warmed up, perform the following operations.

 1. Hold the engine RPM of Ne02 (initial value: 1600 rpm). At that time, check the throttle opening and the airflow usage ratio.
 2. Hold the engine RPM of Ne01 (initial value: 1000 rpm). At that time, check the airflow usage ratio.

3. Input Dec-Air

Select Thr of the deceleration air upper limit setting [Dec.-Air] and input a smaller numeric value than the throttle opening checked in 2-1). Next, select Ne01 and input a larger numeric value than the airflow using ratio checked in 2-2). Lastly, select Ne02 and input a larger numeric value than the airflow using ratio checked in 2-1).

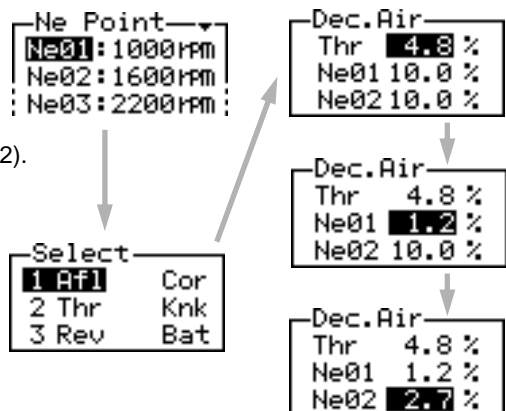

【Setting Menu】 【Knk Set】

Knocking signal correction

Setting is performed to convert a signal obtained from the knock sensor into a knocking level. Corrections are made in the 2 point RPM area for slight knocking signal variation due to different knocking sensor manufacturers, vehicle models, or due to an individual difference within the same model.

This step is indispensable for initial setup.

Note ...When setting this item, do not perform idling on a general public road.

1 Select [Setting] in the main menu

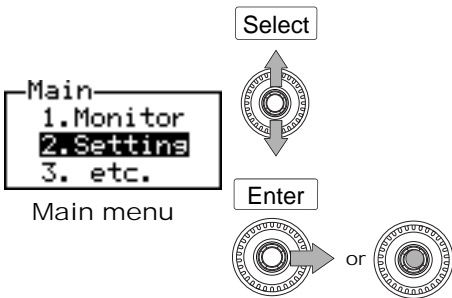

2 Select [Knk Set] in the setting menu

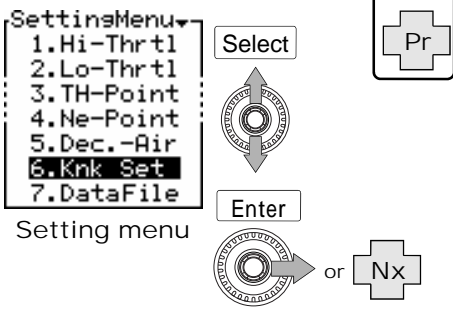

3 The knocking signal correction mode is set

Real-time knocking sensor raw data (not a knocking level)

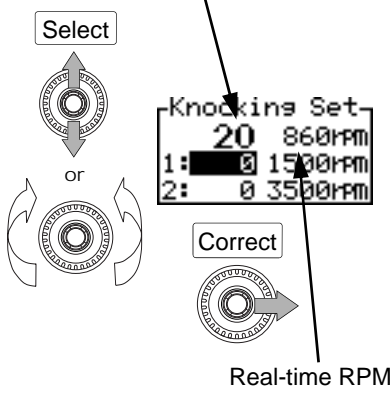

- (1) Select a correction revolution point
Press the upper or lower part of the center switch or turn the rotary switch counterclockwise or clockwise to select a correction RPM point. The selected item is displayed as a reversing display. When the rotary switch is turned clockwise, the cursor is moved upward. When this switch is turned counterclockwise, the cursor is moved downward.
- (2) Perform signal correction
Select a correction RPM point and increase the engine RPM to the specified RPM. Then, press the right part of the center switch to correct the knocking signal.
- (3) End the setting
Select [Pr] in the popup menu after pressing the center push button or press the left part of the center switch, and the setting menu will reappear.

Setting Knk Set

1. Correct RPM 1

Hold the engine RPM at a fixed value between 1300 rpm and 1700 rpm in the no-load status (neutral). (In the example shown on the right, it is held at 1600 rpm.) After the RPM becomes stable, press the right part of the center switch. At completion of correction, the data on RPM and knocking sensor is recorded. (In the example shown on the right, they are 1680 rpm and 27, respectively.) If correction fails, the RPM remains 1500 rpm. Perform correction again in the specified RPM area.

2. Correct RPM 2

In the same way as for the correction of RPM 1, hold the engine RPM at a fixed value between 3200 rpm and 3700 rpm in the no-load status (neutral). (In the example shown on the right, it is held at 3300 rpm.) After the RPM becomes stable, press the right part of the center switch. At completion of correction, the data on RPM and knocking sensor is recorded. (In the example shown on the right, they are 3390 rpm and 48, respectively.) If correction fails, the RPM remains 3500rpm. Perform correction again in the specified RPM area.

3. After completion of correction

Select Knock (Knk) in the monitor mode and check that the mark x disappears on the display. When this mark x disappears, the correction is completed. If not, perform correction once again.

(Example)

```
Knockings Set
  20 860rpm
1: 0 1500rpm
2: 0 3500rpm
```

Increase the RPM to the specified RPM area

Correct



```
Knockings Set
  23 1660rpm
1: 27 1680rpm
2: 0 3500rpm
```

After the RPM becomes stable, press the right part of the center switch

Correct



```
Knockings Set
  42 3350rpm
1: 27 1680rpm
2: 48 3390rpm
```

As shown above, when the RPM becomes stable in the specified RPM area, press the right part of the center switch

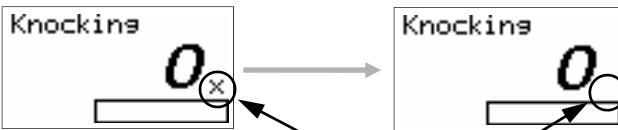

Check if the mark x disappears

NOTE

For a vehicle provided with a genuine knocking sensor signal, be sure to perform setting.

Without this setting, a knocking level value is not displayed in the monitor mode.

For a vehicle without a genuine knocking sensor signal, this feature cannot be used.

Due to the characteristics of factory knock sensors, a knocking level value may be displayed as a lower value even in a situation where damage is being done to the engine from knocking or improper combustion processes ! This is only to be used as a reference.

Data file

1. Select [Setting] in the main menu

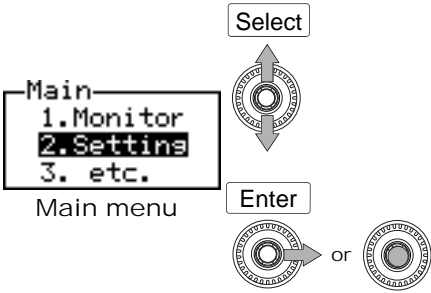

2. Select [Data File] in the setting menu

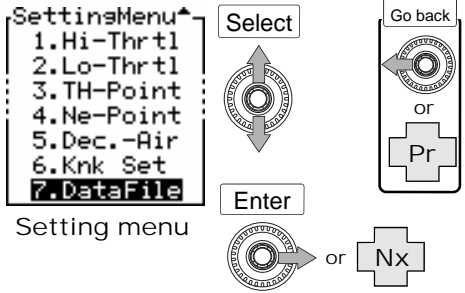

3. The data file control mode is set

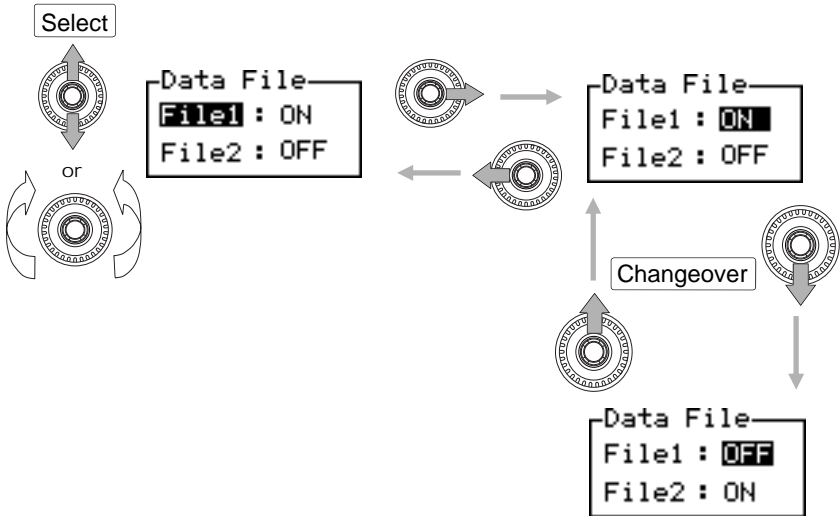

NOTE

Both File 1 and File 2 cannot be turned on or off simultaneously. When one of them is turned on, the other is turned off

(1) Select a data file

Press the upper or lower part of the center switch and turn the rotary switch counterclockwise or clockwise to select a data file. The selected item is displayed as a reversing display. When the rotary switch is turned clockwise, the cursor is moved upward. When this switch is turned counterclockwise, the cursor is moved downward.

(2) Change over the data file between ON and OFF

Select each item and press the right part of the center switch. With this, it can be selected whether the saved data is validated or not (ON/OFF). When the upper part of the center switch is pressed, the saved data is validated (ON).

When the lower part of this switch is pressed, the saved data is invalidated (OFF).

(3) End the setting

Select [Pr] in the popup menu after pressing the center pushbutton or press the left part of the center switch at item selection (File 1, File 2), and the setting menu will reappear.

Saving and loading setting data

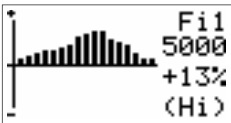

The 4 items (air correction factor Hi/Lo setting, throttle opening setting, air correction engine RPM setting, and deceleration air upper limit setting) can be saved and loaded in the data file.

If any setting is changed in these 4 items, the changed setting is automatically saved in the file (file in the ON status).

< Auto Save function >

In the initial status (at delivery from the factory), File 1 is set to ON and File 2 is set to OFF.

When File 2 is turned on, File 1 is turned off. At this time, the data saved in File 2 is loaded. When File 2 is tuned on for the first time, the initial (factory-set) data is loaded.

If there is a history to indicate that the setting was previously changed by turning on File 2, the changed data is loaded at that time.

Because saving is performed by overwriting, the data to be loaded is the immediately saved data.

When File 1 is turned on, the same can be said.

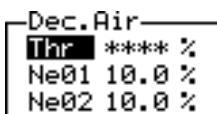
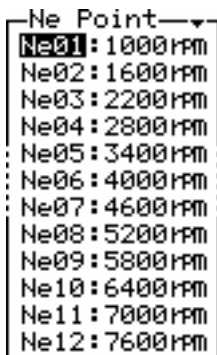
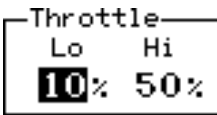

WARNING

Never change over a file during driving

There is a possibility that there may be a large difference in specifications in some setting data causing severe engine damage.

Chapter 6

Etceteras (etc.) Mode

Sensor type and sensor number setting __	44
Number-of-cylinders and throttle sensor type setting _____	50
Sensor check _____	52
Display scale setting _____	53
Warning setting _____	54
Password setting and change _____	56
VFD brightness adjustment _____	58
Program version check _____	59
All data initialization _____	60
What to do in such a case? _____	62

【etc.】 【Sensor Type】

Sensor type and sensor number setting

The sensor type and the sensor number (sensor characteristic) are set according to the vehicle. This item is indispensable for initial setup.

1. Select [etc.] in the main menu

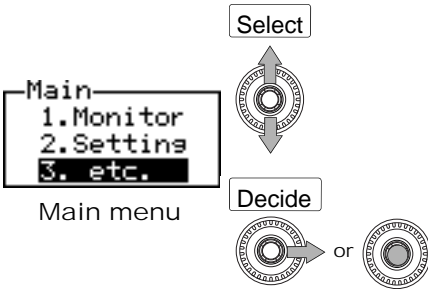

2. Select [Sensor Type] in the etc. menu

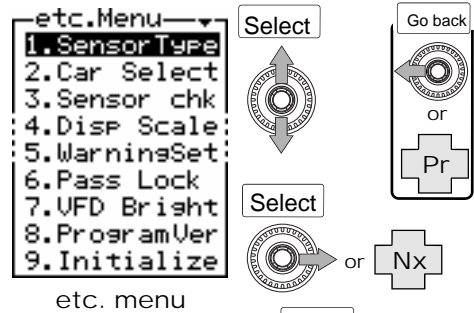

3. The sensor type setting mode is set

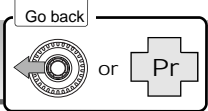

- (1) Select a sensor type
Press the upper or lower part of the center switch and turn the rotary switch counterclockwise or clockwise to select a sensor type. The selected item is displayed as a reversing display. When the rotary switch is turned clockwise, the cursor is moved upward. When this switch is turned counterclockwise, the cursor is moved downward.
- (2) Go to the sensor number setting screen
Select [Nx] in the popup menu after pressing the center pushbutton or press the right part of the center switch, and the sensor number setting screen will appear.
- (3) End the setting
Select [Pr] in the popup menu after pressing the center pushbutton or press the left part of the center switch, and the etc. menu will reappear.

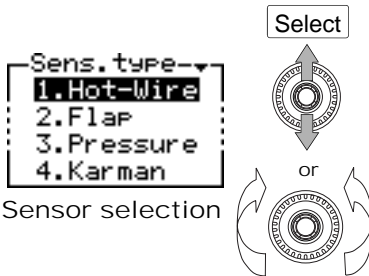

For the sensor types, refer to the Wiring diagram by model on the separate sheet.

The sensor number setting varies depending on the selected sensor type.
 Hot-Wire or Pressure selection P45
 Flap or Karman selection P49

4. Set the sensor number

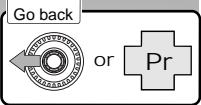

When the sensor type is set to Hot-Wire or Pressure

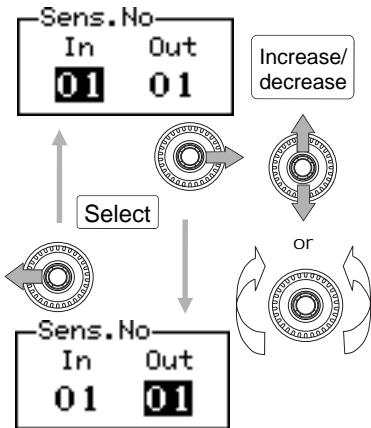

(1) Select In/Out

Operate the left or right part of the center switch to select In or Out. The selected numeric value is displayed as a reversing display.

(2) Set the sensor number

Select a numeric value and press the upper or lower part of the center switch or turn the rotary switch counterclockwise or clockwise to increase or decrease the numeric value.

When the rotary switch is turned clockwise, the numeric value is increased. When this switch is turned counterclockwise, the numeric value is decreased.

(3) End the setting

Select [Pr] in the popup menu after pressing the center pushbutton or press the left part of the center switch at In selection, and the sensor type setting screen will reappear.

For the sensor numbers, refer to the Wiring diagram by model on the separate sheet.

For ordinary use, set the same sensor number between In and Out.

Depending on the car specifications, the In setting and the Out setting must be changed even if the car model is the same.

(Example) Silvia S14 SR20DET '93.10 ~ '98.12

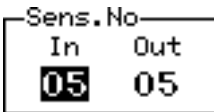

When the ECU and the airflow sensor are Normal

In 05 = S14 normal airflow sensor

Out 05 = S14 normal airflow sensor

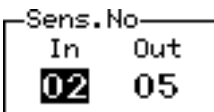

When the ECU is Normal and the airflow sensor is for Z32

In 02 = Z32 airflow sensor

Out 05 = S14 normal airflow sensor

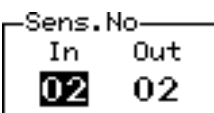

When the ECU has the characteristics of an airflow sensor for Z32 and the airflow sensor is for Z32

In 02 = Z32 airflow sensor

Out 02 = Z32 airflow sensor

For Pressure, the setting is completed

After the setting of the above (3) is completed, exit from the setting screen.

At this time, the set numeric value is saved.

For Hot-Wire, set the sensor output calculation method

Select [Nx] in the popup menu after pressing the center pushbutton or press the right part of the center switch at Out selection, and the sensor output calculation method setting screen will appear.

5. Set the sensor output calculation method

Go back



or

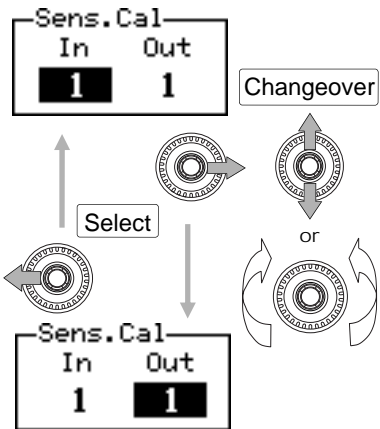

- (1) Select In or Out
Operate the left or right part of the center switch to select In or Out. The selected numeric value is displayed as a reversing display.
- (2) Set the calculation method
Select a numeric value and press the upper or lower part of the center switch or turn the rotary switch counterclockwise or clockwise to select a calculation method. When the rotary switch is turned clockwise, the operation is the same as when the upper part of the center switch is pressed.
- (3) End the setting
Select [Pr] in the popup menu after pressing the center pushbutton or press the left part of the center switch at In selection, and the sensor number setting screen will reappear.

Calculation method operation diagram

Pressing the upper part of the center switch provides the same function as turning the rotary switch clockwise, and pressing the lower part of the center switch provides the same function as turning the rotary counterclockwise.

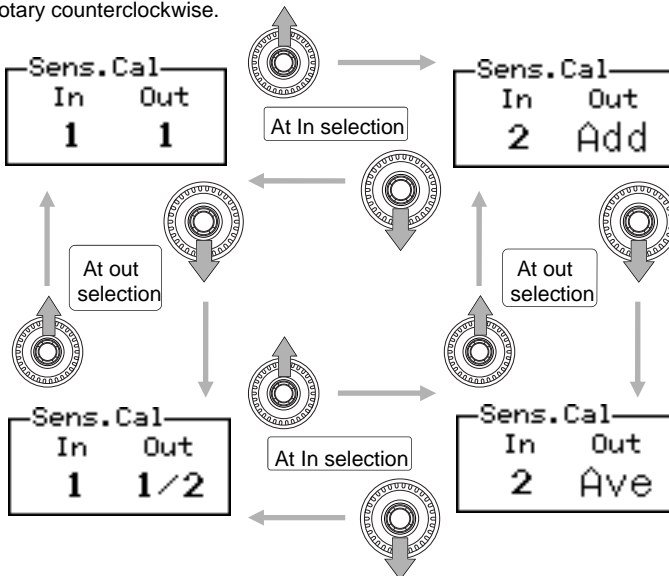

For almost all the models except Skyline GT-R, In 1 and Out 1 are set. For the setting method, refer to the setting examples shown on and after the next page.

Setting the sensor output calculation method (1)

General vehicles (Usually, this setting is performed.)

When the product is used with an airflow sensor and an ECU with single airflow sensor control.

Sens. Cal	
In	Out
1	1

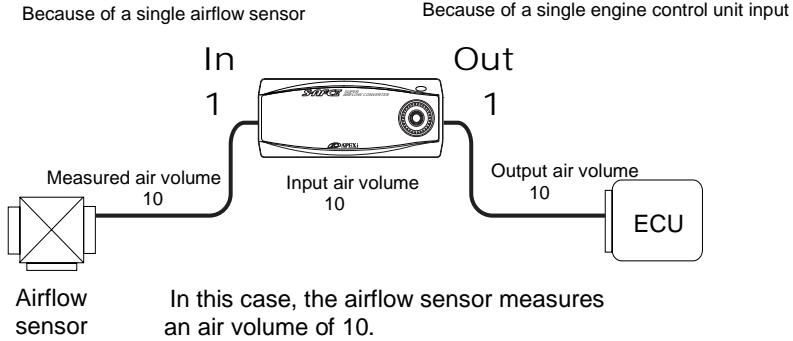

Setting the sensor output calculation method (2)

Skyline GT-R

When the product is used with two airflow sensors and an ECU with twin airflow sensor control.

Sens. Cal	
In	Out
2	Ave

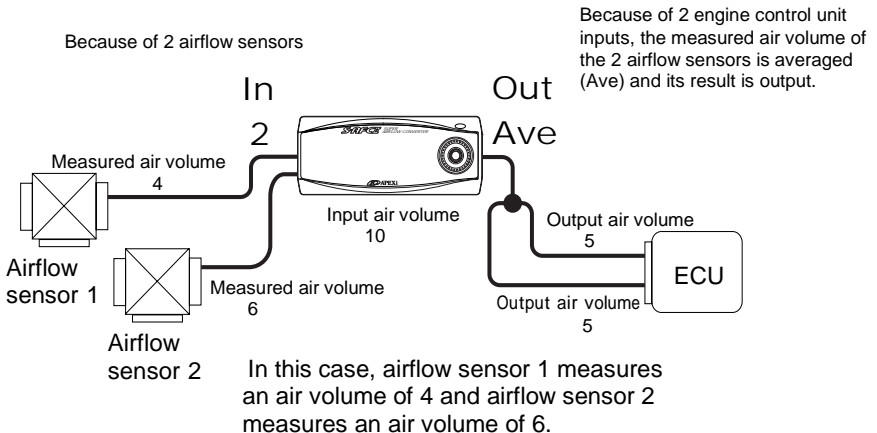

Setting the sensor output calculation method (3)

General vehicles using 2 airflow sensors

When the product is used with two airflow sensors and an ECU with single airflow sensor control.

Sens. Cal	
In	Out
2	Add

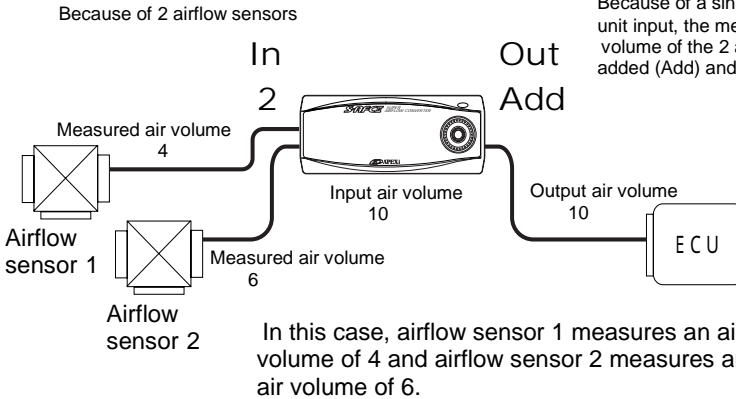

Because of a single engine control unit input, the measured air volume of the 2 airflow sensors is added (Add) and its result is output.

Setting the sensor output calculation method (4)

Skyline GT-R using an airflow sensor

When the product is used with an airflow sensor and an ECU with twin airflow sensor control.

Sens. Cal	
In	Out
1	1/2

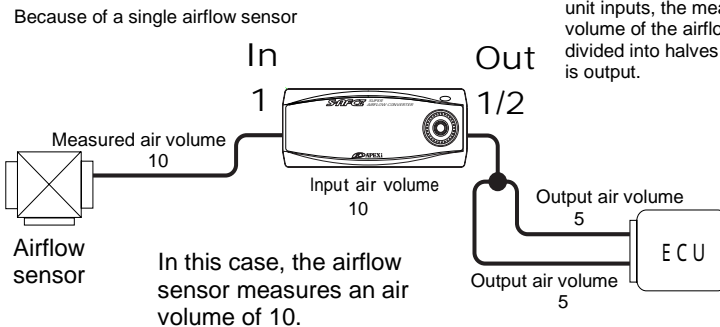

Because of two engine control unit inputs, the measured air volume of the airflow sensor is divided into halves and its result is output.

When the sensor type is Flap or Karman

1. For Flap

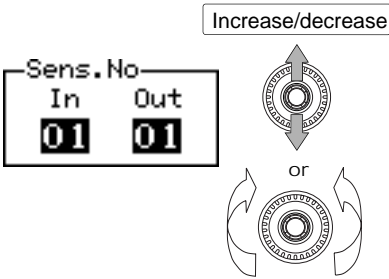

- (1) Set the sensor number
Press the upper or lower part of the center switch or turn the rotary switch counterclockwise or clockwise to increase or decrease the numeric value. When the rotary switch is turned clockwise, the numeric value is increased. When this switch is turned counterclockwise, the numeric value is decreased.

- (2) End the setting
Select [Pr] in the popup menu after pressing the center pushbutton or press the left part of the center switch at In selection, and the sensor type setting screen will reappear.

For the sensor numbers, refer to the Wiring diagram by model on the separate sheet.

2. For Karman

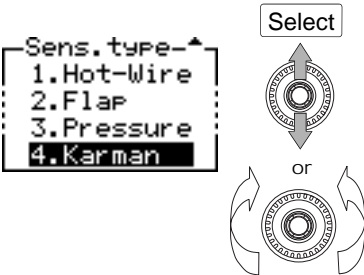

- (1) Select Karman
Press the upper or lower part of the center switch or turn the rotary switch counterclockwise or clockwise to select Karman. The selected item is displayed as a reversing display. When the rotary switch is turned clockwise, the cursor is moved upward. When this switch is turned counterclockwise, the cursor is moved downward.

- (2) End the setting
Select [Pr] in the popup menu after pressing the center pushbutton or press the left part of the center switch, and the etc. menu will reappear.

When Karman is selected, sensor number setting is not required.

【etc.】 【Car Select】

Number-of-cylinders and throttle sensor type setting

Set the number of cylinders and the throttle type according the vehicle. This item is indispensable for initial setup.

1. Select [etc.] in the main menu

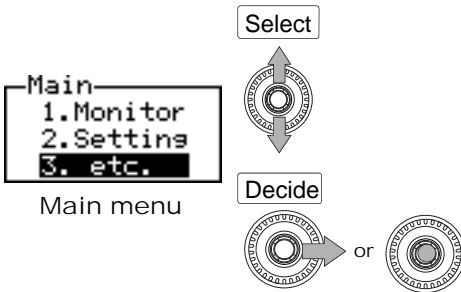

2. Select [Car Select] in the etc. menu

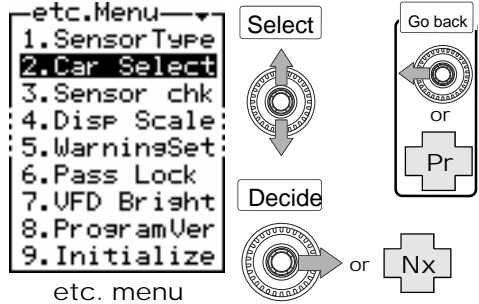

3. The number-of-cylinders and throttle sensor type setting mode is set

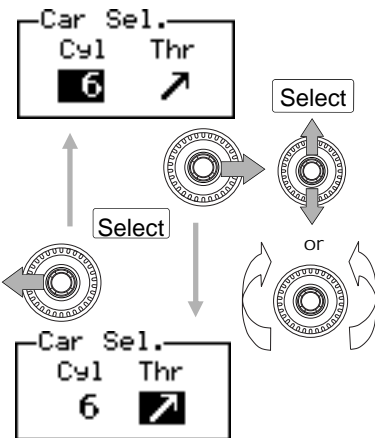
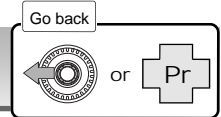

- (1) Select the number of cylinders
Operate the left or right part of the center switch to select the number of cylinders. The selected item is displayed as a reversing display.
- (2) Set the number of cylinders
Select an item and press the upper or lower part of the center switch or turn the rotary switch counterclockwise or clockwise to increase or decrease the numeric value.
When the rotary switch is turned clockwise, the numeric value is increased. When this switch is turned counterclockwise, the numeric value is decreased.

- For a rotary car, set "Number of rotors" × 2
- For a Toyota car mounting a V8 engine, set 4
- For Nissan Fairlady Z (Z33), Skyline (PCV35) set 1
- For Mazda Atenza (GG#/S/P, GY #W), set 2

Setting range	The value in parentheses is the initial value
Cyl [cylinders]	1 ~ 16 (6)
	Settable by 1 cylinder steps

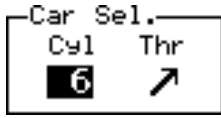

(3) Select the throttle sensor type
Press the upper or lower part of the center switch or turn the rotary switch counterclockwise or clockwise to select the throttle sensor type (Thr). The selected item is displayed as a reversing display.

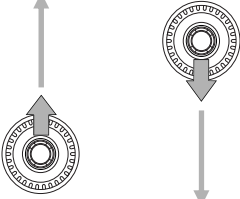

(4) Set the throttle sensor type
Select an item and press the upper or lower part of the center switch or turn the rotary switch counterclockwise or clockwise to change the direction of the arrow (sensor type). When the rotary switch is turned clockwise, the operation is the same as when the upper part of the center switch is pressed. When the rotary switch is turned counterclockwise, the operation is the same as when the lower part of the center switch is pressed.

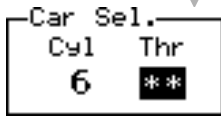

(5) End the setting
Select [Pr] in the popup menu after pressing the center pushbutton or press the left part of the center switch at number-of-cylinders (Cyl) selection, and the etc. menu will reappear.

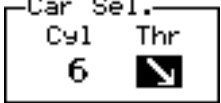
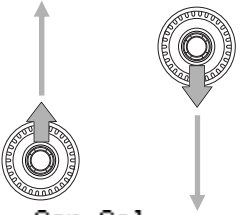

When the throttle is completely closed, the throttle sensor voltage is 0 V to 1 V.
When the throttle is completely opened, the throttle sensor voltage is 3 V to 5 V.

Select



When the throttle is completely closed, the throttle sensor voltage is 3 V to 5 V.
When the throttle is completely opened, the throttle sensor voltage is 0 V to 1 V.

* * No throttle signal

Set the throttle sensor type after checking the voltage in the completely closed/opened status of the throttle in the sensor voltage check mode described on the next page.

NOTE

When No throttle signal (* *) is set, correction is not performed by throttle opening, so you can set only the Hi mode [Hi-Thrtl] in the air correction factor setting mode. The Lo mode [Lo-Thrtl] cannot be selected. In the monitor mode, the throttle opening cannot be monitored.

【etc.】 【Sensor chk】

Sensor check

The airflow sensor voltage, pressure sensor voltage, throttle sensor voltage, and knocking sensor output value are checked.

After wiring, each connection can be checked for normality and each sensor status can be checked. When setting the throttle sensor type on the previous page, it is necessary to check the throttle sensor voltage.

Regarding a vehicle provided with multiple knocking sensors, the sensor output value of each knocking sensor signal is checked, and wiring is performed to a sensor signal wire with the highest output value.

1. Select [etc.] in the main menu

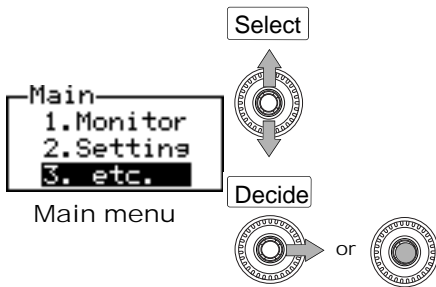

2. Select [Sensor Chk] in the etc. menu

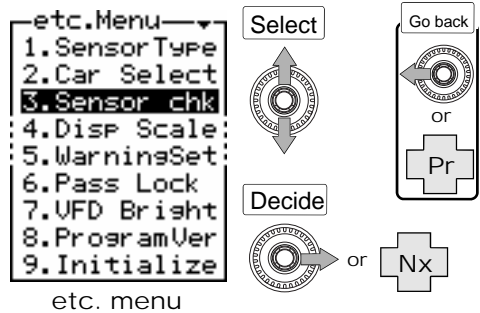

3. The sensor check mode is set

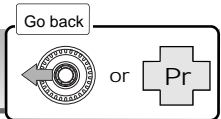

In-1 Airflow sensor voltage 1
Pressure sensor voltage

```
Sens. Check
In-1: 1.364 V
In-2: 1.382 V
Thrt: 4.257 V
Knk : 00169
```

In-2 Airflow sensor voltage 2
(For a twin airflow car only)

Thrt Throttle sensor voltage
(For a car with a throttle sensor only)

Knk Knocking sensor output value
(For a car with a knocking sensor only)

End the check
Select [Pr] in the popup menu after pressing the center pushbutton or press the left part of the center switch, and the etc. menu will reappear.

NOTE

The knocking sensor output value is raw data including noise that was obtained from the genuine knocking sensor. Accordingly, a higher numeric value than the actual knocking level is displayed. This is not abnormal. (Not a knocking level)

【etc.】 【Disp Scale】

Display scale setting

A graphic display and an analog display in the monitor mode are made and a graph scale in the two-dimensional trace mode is set. As a pressure display, one of kg/cm^2 and kPa can be selected.

1. Select [etc.] in the main menu

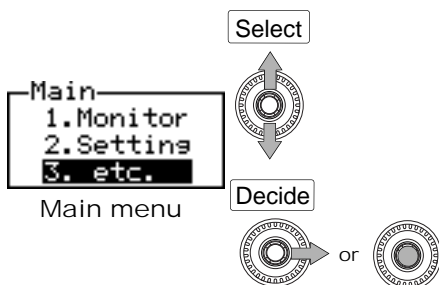

2. Select [Disp Scale] in the etc. mode

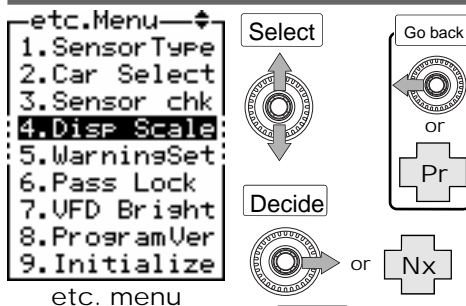

3. The display scale setting mode is set

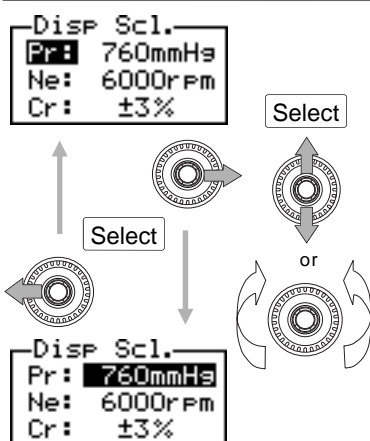

(1) Select an item

Press the upper or lower part of the center switch and turn the rotary switch counterclockwise or clockwise to select an item to set a numeric value. The selected item is displayed as a reversing display. When the rotary switch is turned clockwise, the cursor is moved upward. When this switch is turned counterclockwise, the cursor is moved downward.

(2) Set a numeric value

Select a numeric value and press the right part of the center to set the numeric value. Press the upper or lower part of the center switch and turn the rotary switch counterclockwise or clockwise to increase or decrease the numeric value. When the rotary switch is turned clockwise, the numeric number is increased. When this switch is turned counterclockwise, the numeric value is decreased

For setting another item

Operate the left part of the center switch and repeat steps (1) and (2).

(3) End the setting

Select [Pr] in the popup menu after pressing the center pushbutton or press the left part of the center switch at item selection, and the etc. menu will reappear.

Setting range The value in parentheses is the initial value

Pr : 760 ~ -100 [mmHg] / 0,+1.0,+2.0 [$\text{k g}/\text{c m}^2$]
0,+100,+200 [kPa] (760mmHg)

Ne : 6000 ~ 10000 [rpm] (6000)

Cr : $\pm 3, \pm 6, \pm 9, \pm 15, \pm 30$ [%] (± 3)

【etc.】 【Warning Set】

Warning setting

Regarding the airflow using ratio, suction tube pressure, Karman swirl sensor frequency, knocking, or engine revolution speed, the indicator blinks to give a warning to the driver when the indicated value exceeds the set warning value.

1. Select [etc.] in the main menu

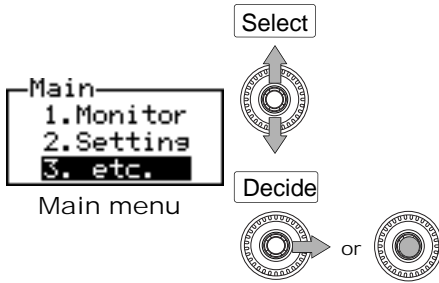

2. Select [Warning Set] in the etc. menu

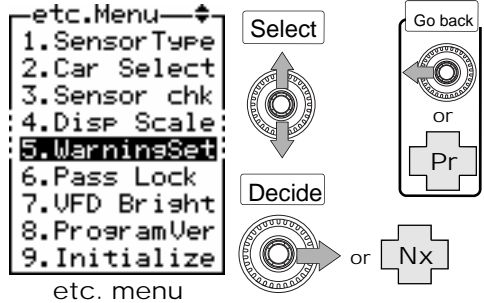

3. The warning setting mode is set

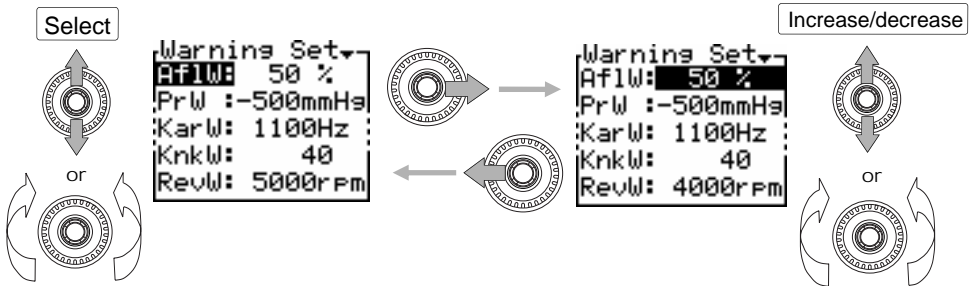
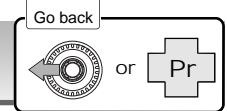

When the unit of pressure display is set to Pascal (kPa) in the display scale setting on the previous page, the unit of pressure warning in this item is changed into Pascal (kPa).

```
Warning Set
Af1W 50 %
PrW :-100kPa
KarW :1100Hz
KncW : 40
RevW :4000rpm
```

(1) Select an item

Press the upper or lower part of the center switch and turn the rotary switch counterclockwise or clockwise to select an item to set a numeric value. The selected item is displayed as a reversing display. When the rotary switch is turned clockwise, the cursor is moved upward. When this switch is turned counterclockwise, the cursor is moved downward.

(2) Set a numeric value

Select a numeric value and press the right part of the center to set the numeric value. Press the upper or lower part of the center switch and turn the rotary switch counterclockwise or clockwise to increase or decrease the numeric value. When the rotary switch is turned clockwise, the numeric number is increased. When this switch is turned counterclockwise, the numeric value is decreased.

For setting another item

Operate the left part of the center switch and repeat steps (1) and (2).

(3) End the setting

Select [Pr] in the popup menu after pressing the center pushbutton or press the left part of the center switch at item selection (AfIW, PrW, KarW, KnkW, RevW), and the etc. menu will reappear.

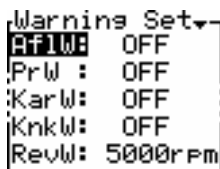

When the warning value for the engine revolution speed is set to 5000 rpm.

When exceeding the set warning value ...

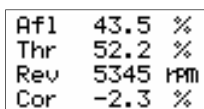

A reversing/blinking display is repeated.

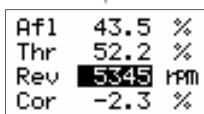

Monitor mode

Setting range	The value in parentheses is the initial value
A f I W [Airflow using ratio]	50 ~ 100 OFF (OFF) [%] Settable by 5% steps
P r W [Suction tube pressure]	-500 ~ 2.0 OFF (OFF) [kg/cm ²] Settable by 100 mmHg for the negative side and 0.2 kg/cm ² steps for the positive side
	-100 ~ 200 OFF (OFF) [kPa] Settable by 20 kPa steps
K a r W [Karman swirl sensor frequency]	200 ~ 1600 OFF (OFF) [Hz] Settable by 100 Hz steps
K n k W [Knocking]	10 ~ 200 OFF (OFF) Settable by 20 steps
R e v W [Engine revolution speed]	3000 ~ 9000 OFF (OFF) [rpm] Settable by 500 rpm steps

【etc.】 【Pass Lock】

Password setting and change

When a password is optionally set, this can prevent setup data or setting data from being changed by disoperation or mischief.

1. Select [etc.] in the main menu

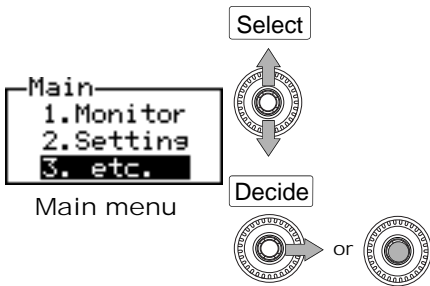

2. Select [Pass Lock] in the etc. menu

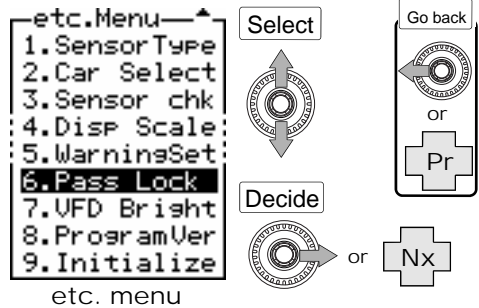

3. The password setting/change mode is set

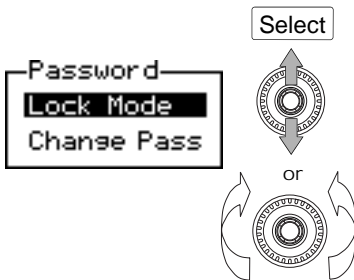

(1) Select an item

Press the upper or lower part of the center switch and turn the rotary switch counterclockwise or clockwise to select an item. The selected item is displayed as a reversing display. When the rotary switch is turned clockwise, the cursor is moved upward. When this switch is turned counterclockwise, the cursor is moved downward.

(2) Set or change a password

Select [Nx] in the popup menu after selecting an item and pressing the center pushbutton, or press the right part of the center switch to go to the password input screen.

(3) End the setting

Select [Pr] in the popup menu after pressing the center pushbutton or press the left part of the center switch, and the etc. menu will reappear.

NOTE

Take a note of the set password lest you should forget it.
Avoid setting an easy-to-remember password such as 1111 and AAAA.

When selecting Lock

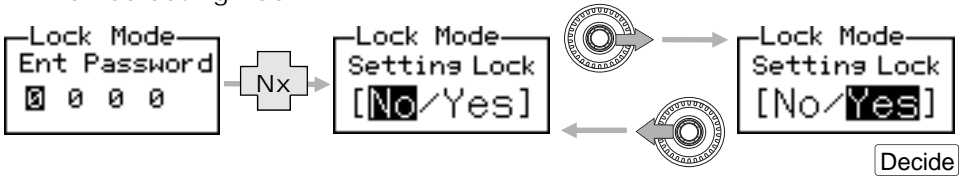

(1) Input the password

Turn the rotary switch counterclockwise or clockwise and input a password. For the password, select characters from 0 to 9 and A to Z. Operate the left or right part of the center switch to shift a digit. (In the initial status, the password is 0000.) After inputting the password, press the center pushbutton and select [Nx] in the popup menu. To abort it, select [Pr] or [Tp] in the popup menu to exit from the mode.

(2) Lock the setup/setting

Press the right part of the center switch, select [Yes], and press the center pushbutton. If you do not lock the setup/setting, select [No] and press the center pushbutton.

When selecting Change Pass

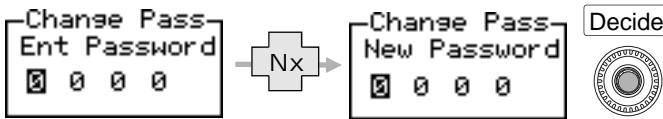

(1) Input the password

Input the current password by performing the same procedure as that for Lock Mode. (In the initial status, the password is 0000.) After inputting the password, press the center pushbutton and select [Nx] in the popup menu. To abort it, select [Pr] or [Tp] in the popup menu to exit from the mode.

(2) Input a new password

Input the new password by performing the same procedure as before. After inputting the password, press the center pushbutton.

If a password is wrongly input on the Ent Password screen, the warning screen shown at right appears. Input a correct password again.

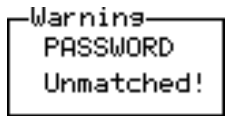

Items for which a setting change is prohibited by Password Lock.

- Setting Menu··· All items
- etc. Menu······· Sensor Type · Car Select

If an attempt to change any item shown above is made in the Password Lock status, a warning screen appears.

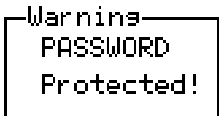

【etc.】 【VFD Bright】

VFD brightness adjustment

In this product, the VFD brightness is automatically adjusted according to the outside lightness by using a built-in optical sensor. It is supposed that the item [Day] is for the brightness of the daytime (bright time), [Dim] is for the brightness of the evening time (dim time), and [Nig] is for the brightness of the nighttime (dark time)

Make an adjustment, for example, when the light is dazzling at night. Usually, any change is not required.

1. Select [etc.] in the main menu

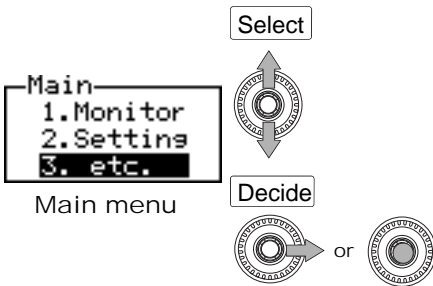

2. Select [VFD Bright] in the etc. menu

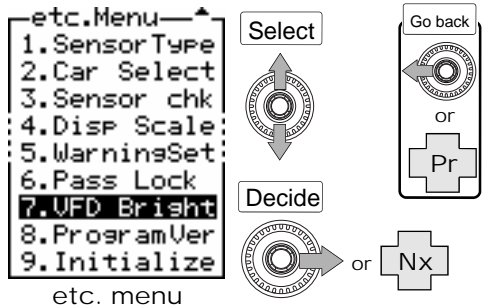

3. The VFD brightness adjustment mode is set

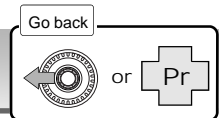

(1) Select an item

Press the left or right part of the center switch to select an item to set a numeric value. The selected item is displayed as a reversing display.

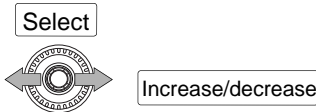

(2) Set a numeric value

Select a numeric value and press the upper or lower part of the center switch or turn the rotary switch counterclockwise or clockwise to increase or decrease the numeric value. As the numeric value is increased, it becomes brighter. As the numeric value is decreased, it becomes darker. When the rotary switch is turned clockwise, the numeric number is increased. When this switch is turned counterclockwise, the numeric value is decreased.

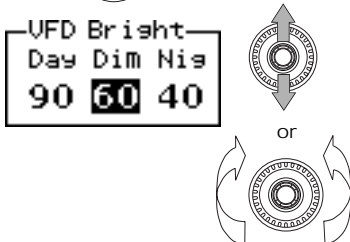

(3) End the setting

Select [Pr] in the popup menu after pressing the center pushbutton or press the left part of the center switch at [Day] or press the left part of the center switch at [Nig], and the etc. menu will reappear.

【etc.】 【Program Ver.】

Program version check

1. Select [etc.] in the main menu

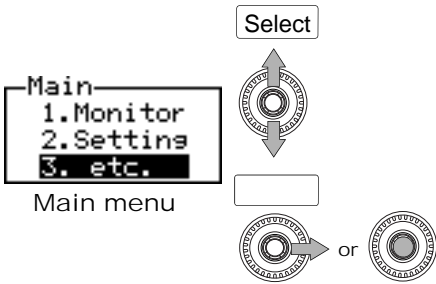

2. Select [Program Ver] in the etc. menu

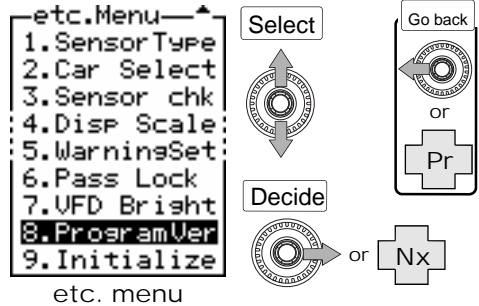

3. The program version check mode is set

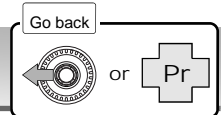

The program version information is displayed.

```
Program Ver.
SAFCII
Ver. *.*
```

End the check

Select [Pr] in the popup menu after pressing the center pushbutton or press the left part of the center switch, and the etc. menu will reappear.

【etc.】 【Initialize】

All data initialization

Initialize all data to return it to the data status provided at delivery from the factory.

1. Select [etc.] in the main menu

2. Select [Initialize] in the etc. menu

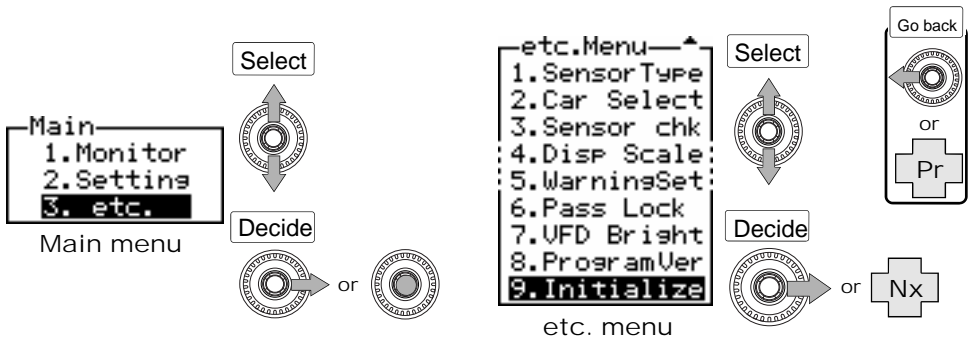

3. The all data initialization mode is set

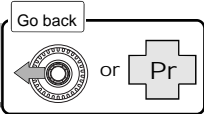

Decide



Initialize
Init. All?
[No/Yes]

Initialize all data

In the all data initialization mode, operate the right part of the center switch, select [Yes], and press the center pushbutton. After that, turn off the ignition switch.

Exit from the mode without initialization

In the all data initialization mode, perform one of the following operations.

- Select [No] and press the center pushbutton.
- When [No] has been selected, operate the left part of the center switch.
- When [Yes] has been selected, operate the right part of the center switch.

Then, the etc. menu will reappear.

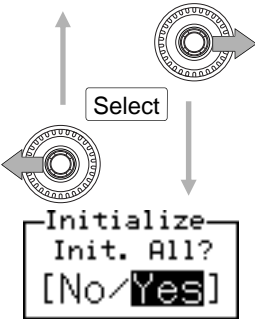

Memo

What to do in such a case ?

Fault related to the power supply



Check if the battery is connected.
Check if the vehicle ECU harness is securely connected to the signal harness.
Check if the signal harness is connected to the connector of the SAFC main unit cable.

Even if the connection is properly made, the power supply may not be turned on because of a contact defect. Check the plug and splice caulking portion once again.

The power supply is turned off because of vibrations.

This may be due to a wiring contact defect.

The display is not normal



Each signal is not displayed. (monitored)

Check if the harness connecting position is correct. Install the harness by referring to the "Wiring diagram by model" attached to this product, taking special care about the direction of the ECU, and checking the connector shape and the number of pins.

The revolution speed display is not normal.

- Check if the number of cylinders is correctly is set.
- Genuine tachometers have a slight error. Even when a deviation of 200 to 300 rpm occurs at a high-speed revolution, this is normal. The numeric value of this product is a correct revolution speed.

The throttle opening display is not normal.

- Check if the throttle sensor type has been set.
- Check if the throttle opening has been learned.
- For a vehicle without throttle opening signal, the throttle display cannot be performed.

Throttle opening Hi/Lo cannot be selected.

Check if the throttle type is not set to * * If it is set to * * correction is not made by throttle opening, so the Hi/Lo map cannot be changed over.

The pressure display does not move.

- For an airflow car (Hot Wire, Flap or Karman), the pressure display does not move.
- For a pressure sensor type car only, the pressure display can be monitored.

The engine is out of order



An engine stall occurs.

- Check if the harness is connected to a wrong position.
Install the harness by referring to the “Wiring diagram by model” attached to this product, taking special care about the direction of the ECU, and checking the connector shape and the number of pins.
- Check if the sensor type is wrongly set.

Idling is unstable.

- Check if the harness is securely connected.
- Check if the sensor type is wrongly set.

The engine check lamp comes on.

- Check if the harness is securely connected.
- Check if the sensor type is wrongly set.

The engine does not blow.

- Check if the harness is securely connected.
- Check if the sensor type is wrongly set.
- Check if the fuel is not set to an extremely thick level by the correction factor setting.

The engine seems to be overloaded.

- Check if the harness is securely connected.
- Check if the sensor type is wrongly set.
- Check if the fuel is not set to an extremely thick level by the correction factor setting.

The engine fails to start.

- Check if the harness is securely connected.
- Check if the sensor type is wrongly set.

Knocking occurs.

- Check if the fuel is not set to an extremely thick level by the correction factor setting.

The display is dark or bright



- Make a VFD brightness adjustment. (P58)

The password has been forgotten



- Initialize the main unit. (P60)

Notes

1. The contents of this document are subject to change without previous notice.
2. The contents of this document have been prepared with extreme care. However, if you find a doubt, error, or other fault, inform us of it.
3. A part or all of this document may not be reproduced in any form without prior written permission, and also may not be used without the prior written permission of A'PEX CO., LTD. under the copyright except for private use.
4. We shall disclaim all the responsibility for any damage resulting from a loss of memory data due to a failure, repair, or any other reason.
5. The specifications, price, and appearance of this product are subject to change without previous notice.

-
- The company names and product names described in this document are the registered trademarks or brands of the respective companies.
 - The names, addresses and telephone numbers mentioned as where to contact are as of December 10, 2002. Note that this information is subject to change.

Specifications of This Product

Operating voltage DC10V ~ 16V
 Operating temperature -20 ~ +60

Warranty

This product is warranted under the contents of the separate warranty. Confirm the contents of the warranty and enter necessary items. Keep the warranty in your custody.

Revision Record

No.	Date of issue	Part No. of instruction manual	Edition	Change of description
1	Dec. 10, 2002	7107-0230-00	First edition	

Where to contact _____ <http://www.apexi.co.jp>

Authorized Agencies

TAIWAN	AAI MOTORSPORTS CO.,LTD B1, NO. 162, Jian-Yi Road, Jung-He City Taipei, Taiwan	+886-2822-63988	+886-2822-65788
HONG KONG	GT SPORTS LTD DD 115 Lot 1045 BRP, Castle Peak, Road, Au Tau Yuen Long, NT Hong Kong	+852-2398-8866	+852-2398-8862
AUSTRALIA	ACCESS AUTO ENGINEERING PTY. 9 Traid Place Vermont Vic.3133 Australia	+61-3-9873-0133	+61-3-9873-1311
MALAYSIA	SPEEDWORKS (M) SDN. BHD		
SINGAPORE	Lot2, Lorong 51A/227B, Section 51A, 46100 Petaling Jaya, Selangor, Malaysia	+603-7955-5533	+603-7955-7745
KOREA	CAREX CO., LTD 787-15 Youksam-Dong, Kangnam-ku, Seoul,	+82-2-508-4646	+82-2-508-2244

Contact

Apex Integration, Inc	330 W. Taft Orange, CA 92865	+1-714-685-5700	+1-714-685-5701
Apex Co., Ltd.	1-17-14 Tanashioda, Sagamihara-city, Kanagawa, 229-1124 Japan	+81-42-778-3991	+81-42-778-4495